

OTR and Signal

CSE 468 Fall 2024

jedimaestro@asu.edu

[https://en.wikipedia.org/wiki/Source_\(journalism\)](https://en.wikipedia.org/wiki/Source_(journalism))

- **"On the record"**: all that is said can be quoted and attributed.
- **"Unattributable"**: what is said can be reported but not attributed.
- **"Off the record"**: the information is provided to inform a decision or provide a confidential explanation, not for publication.



<https://www.theguardian.com/film/2014/oct/11/citizenfour-review-snowden-vindicated-poitras-nsa-journalism>



(TS//SI//NF) Dates When PRISM Collection Began For Each Provider

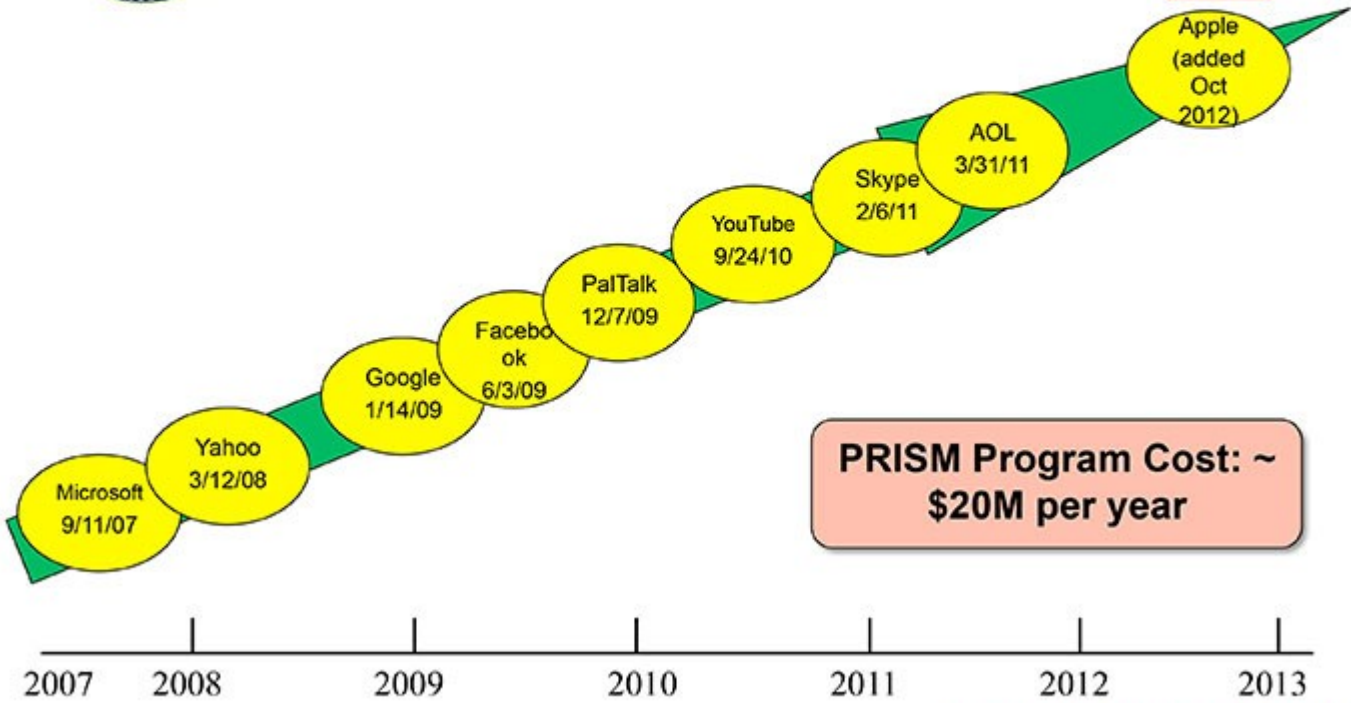

PRISM Program Cost: ~ \$20M per year

2007 2008 2009 2010 2011 2012 2013

OTR

- Off-The-Record messaging
- 2004, Nikita Borisov, Ian Goldberg, Eric Brewer. "Off-the-Record Communication, or, Why Not To Use PGP"
- (PGP is from 1991, basically RSA for email)



<https://otr.cypherpunks.ca/help/3.2.0/authenticate.php?lang=en>

Requirements, OTR vs. TLS...

- Forward secrecy
 - Both OTR and TLS care, for different reasons
- Deniable authentication *a.k.a.* off-the-record
 - TLS doesn't care about this, OTR does
- Future secrecy
 - TLS doesn't care about this, OTR does it by accident
- Out-of-order messages, parties offline for long periods of time, groups...
 - TLS doesn't need to worry about any of these, nor does OTR (Signal does)

Off-The-Record (OTR) Messaging

- Based on Diffie-Hellman and AES, and originally SHA-1
 - There are new versions
- Deniable Authentication
 - “Off the record” in journalism
- Forward secrecy
 - Ephemeral key exchange
- Future secrecy (not a design goal, but has it)

Deniable Authentication

- Concept of “malleability”
- Basic idea has two parts:
 - Hash the decryption key for a message, use the hash digest as an authentication key
 - Reveal the authentication key in the next message

Forward secrecy

- If Alice or Bob's key is compromised, past messages cannot be decrypted by the adversary

Ratchet in sailing...



<https://www.westmarine.com/harken-snubbair-ratcheting-drum-19471861.html>

Forward Secrecy (ratchet)

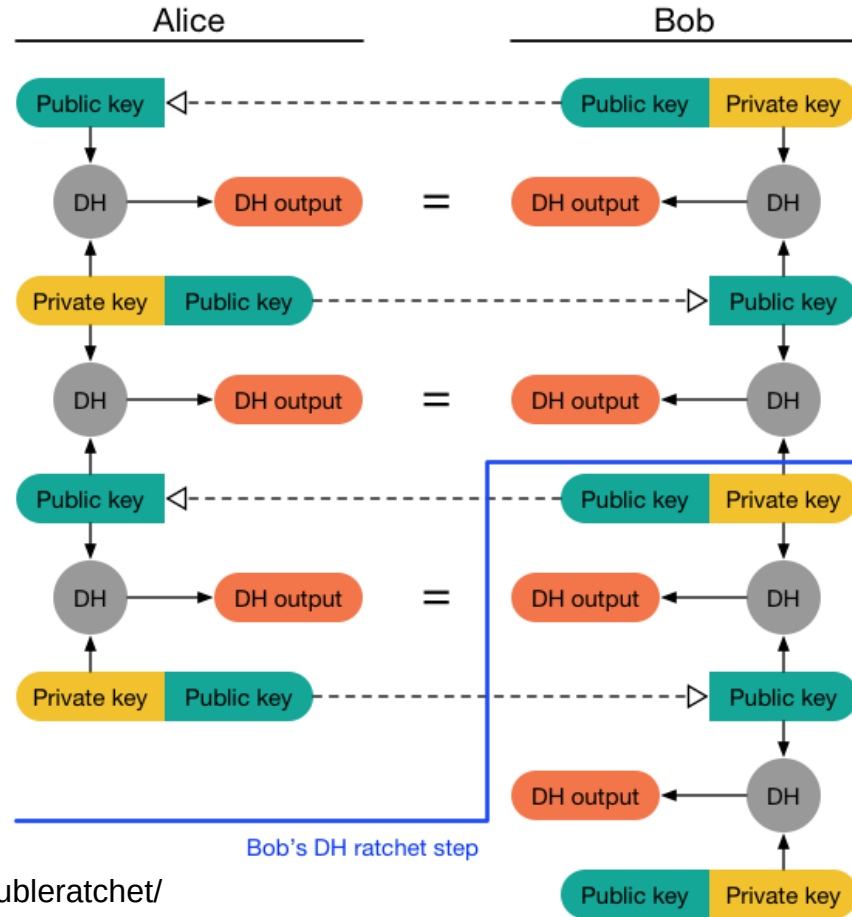

Future Secrecy

- *Future* secrecy is not the same as *forward* secrecy, and is in fact sometimes called *backward* secrecy
- If a private key is compromised, the attacker needs to intercept every message thereafter or else the crypto will “self heal”
- We get this for free because of the Diffie-Hellman key exchange every time we ratchet in OTR

Signal

- Multiple devices, some or all can be offline for long periods of time
- Group messages

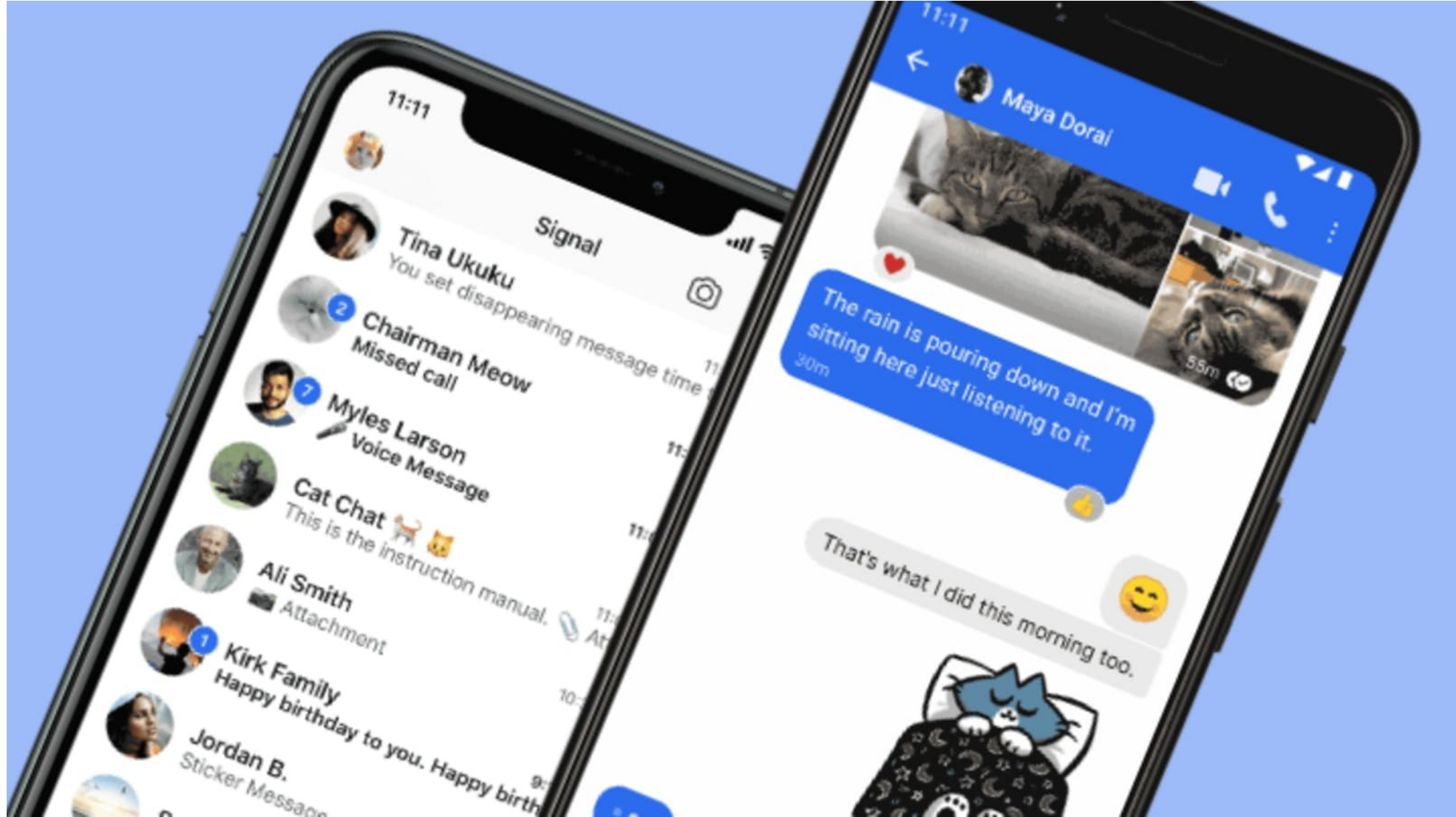

Typical authentication

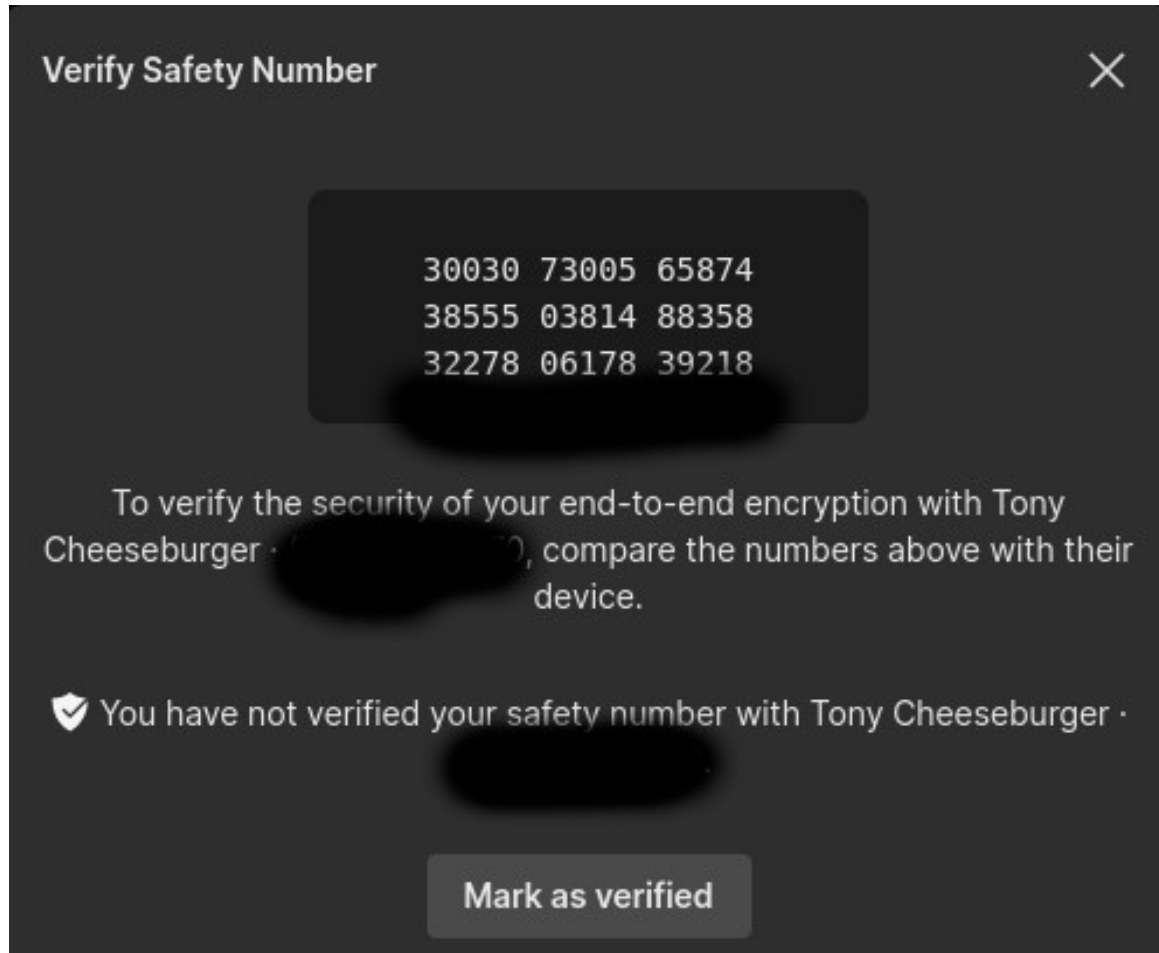

Signal encryption basics

- AES-256 in CBC mode
 - Why not a stream cipher?
- HMAC-256 with SHA-256 (SHA-2)
- Curve25519 for key exchange and signatures

The following about ECC is just FYI, you will not use it for an assignment or be tested on it this semester...

Elliptic
Curve

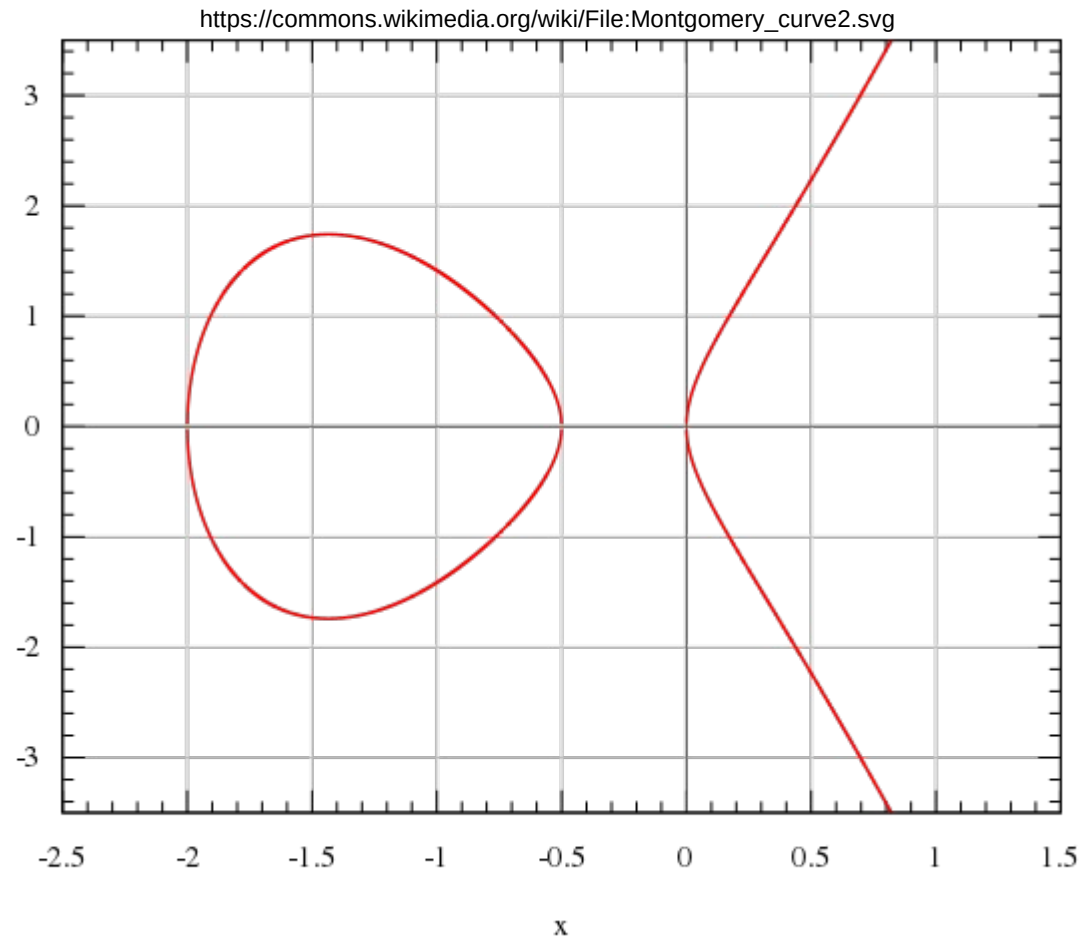
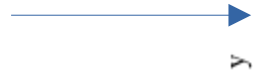

ECC background

- “The use of elliptic curves in cryptography was suggested independently by Neal Koblitz[7] and Victor S. Miller[8] in 1985. Elliptic curve cryptography algorithms entered wide use in 2004 to 2005.” -- Wikipedia
- SSL/TLS, Signal, LINE, WhatsApp, Viber, SSH, Matrix, WireGuard, Tor, I2P, ProtonMail, ... use it

$$y^2 = x^3 + ax + b$$

Following figures are from...

<https://blog.cloudflare.com/a-relatively-easy-to-understand-primer-on-elliptic-curve-cryptography/>

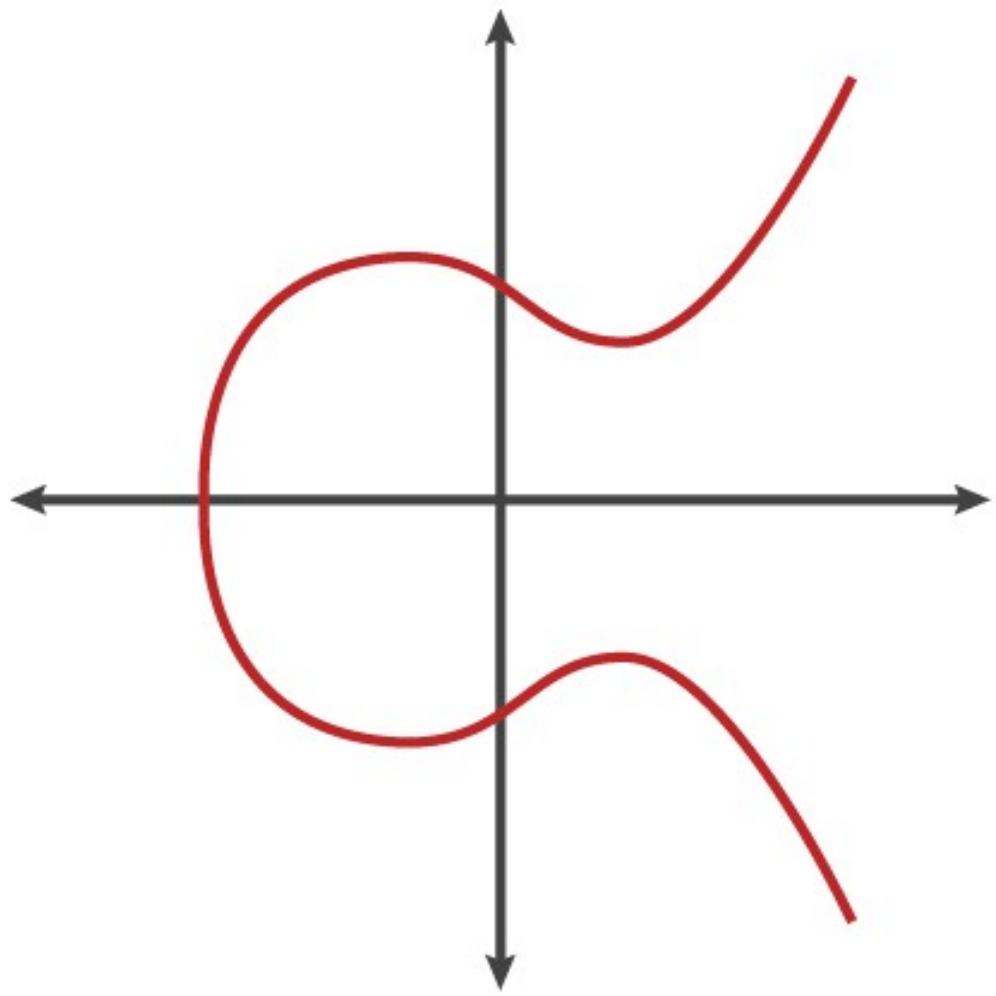

https://en.wikipedia.org/wiki/Elliptic_curve_point_multiplication#/media/File:ECCLines.svg

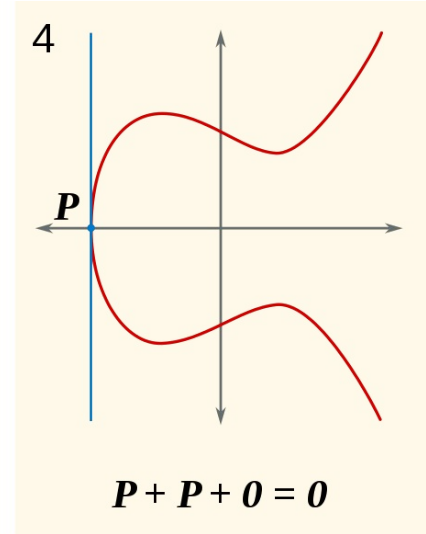
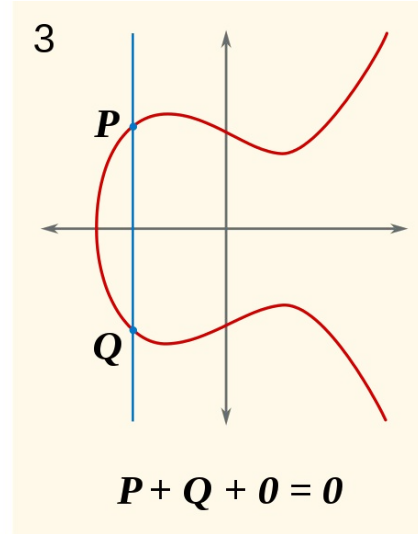
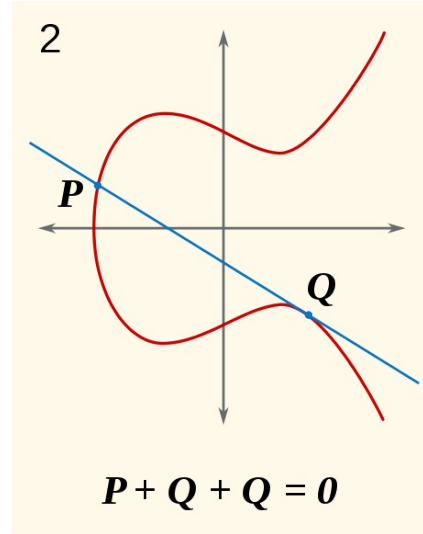
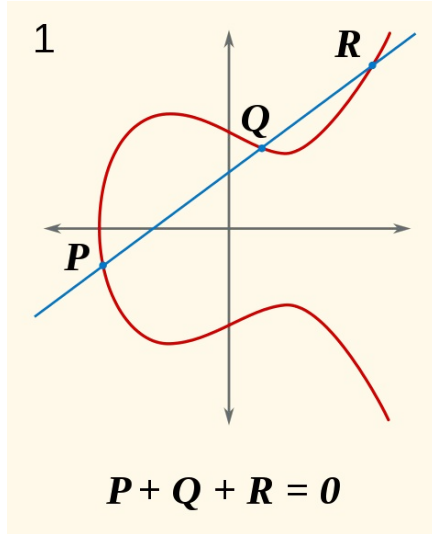

O is point at infinity, serves as identity

How to calculate “ $C = A + B$ ”?

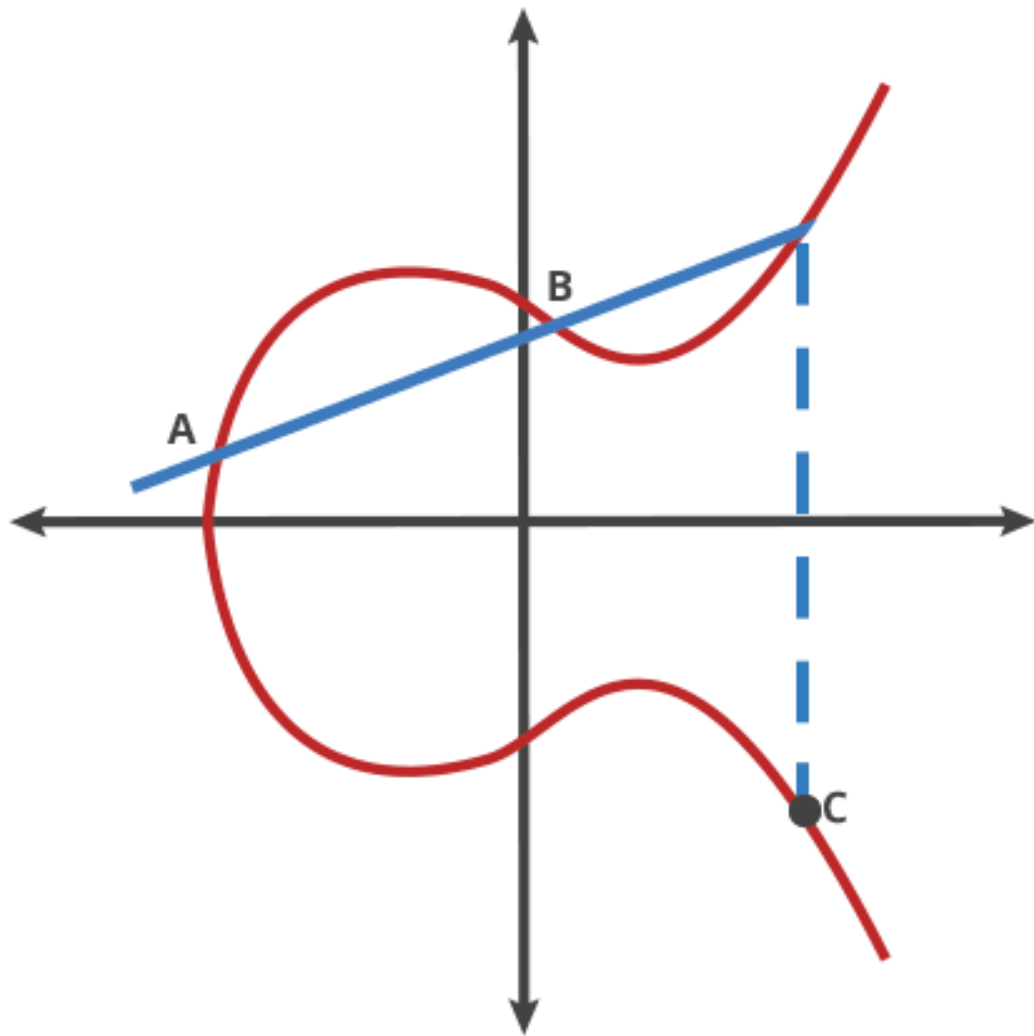

How to calculate?

- $C = -A$ (negation)
- $C = 2A$ (doubling)
 - Or, $C = A + A$
- $C = nA$
 - What if n is some astronomically large number?

https://en.wikipedia.org/wiki/Elliptic_curve_point_multiplication#/media/File:ECCLines.svg

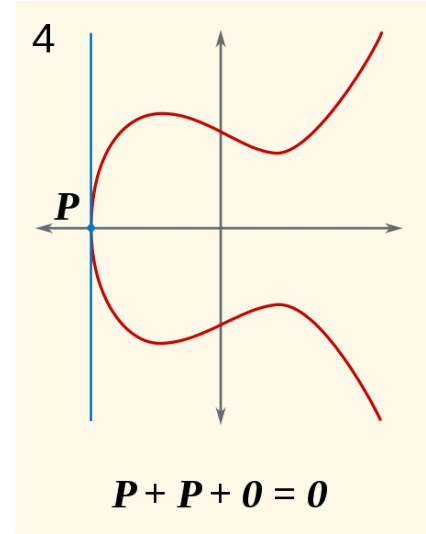
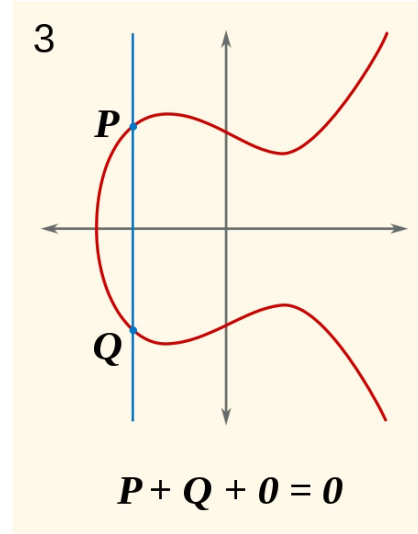
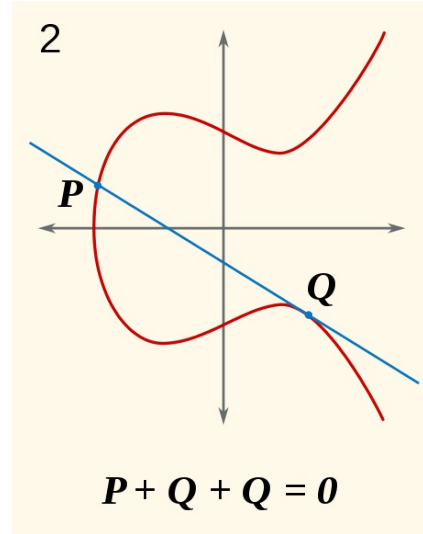
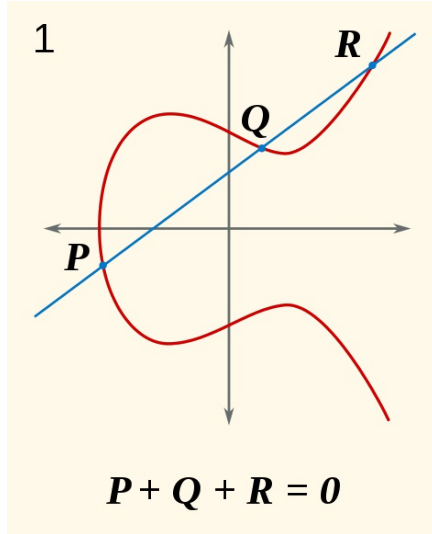

O is point at infinity, serves as identity

How to calculate?

- $C = -A$ (negation)
- $C = 2A$ (doubling)
 - Or, $C = A + A$
- $C = nA$
 - What if n is some astronomically large number?
 - Double and add (like “square and multiply” for modular exponentiation) ... Trap door function!

More figures stolen from...

<https://blog.cloudflare.com/a-relatively-easy-to-understand-primer-on-elliptic-curve-cryptography/>

Here's an example of a curve ($y^2 = x^3 - x + 1$) plotted for all numbers:

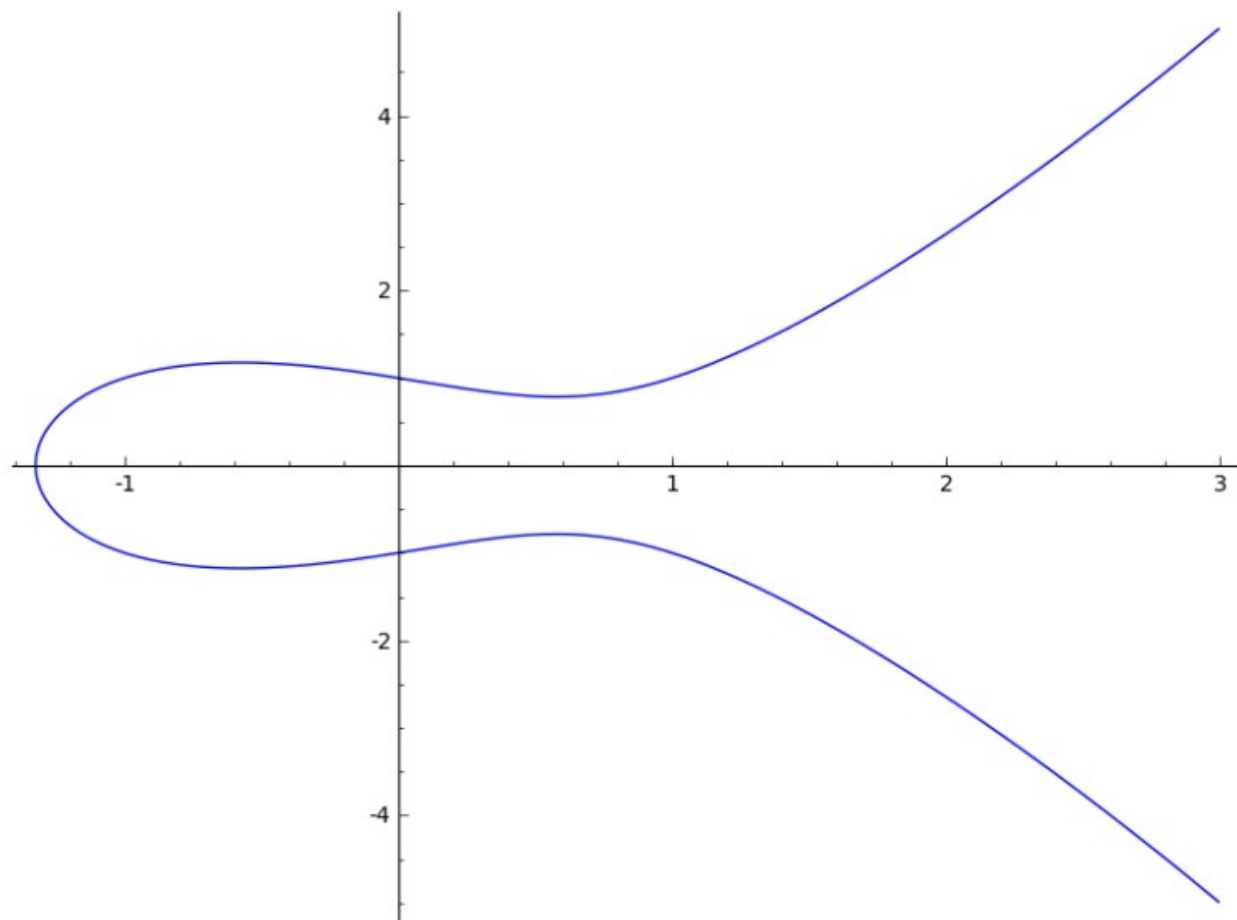

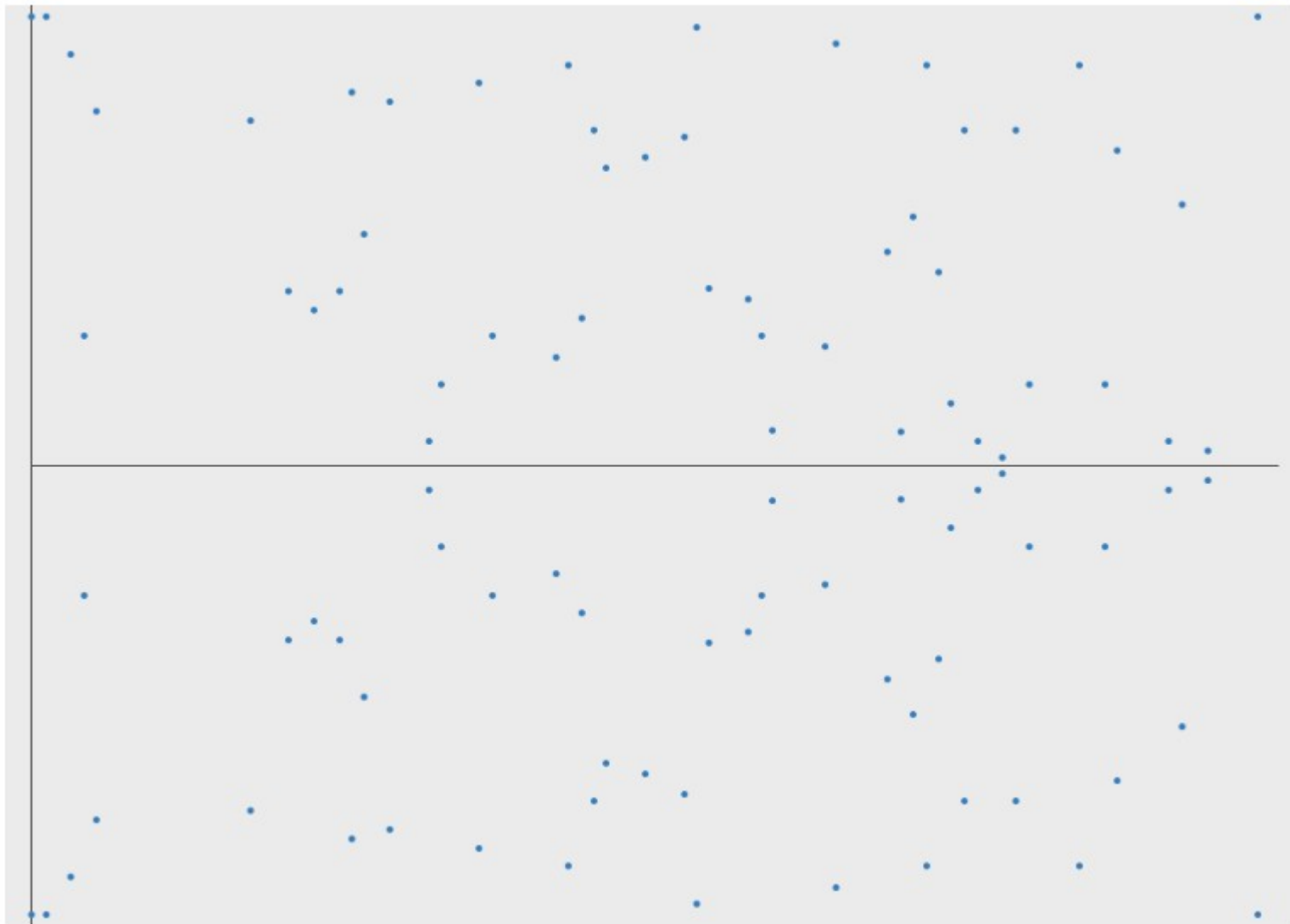

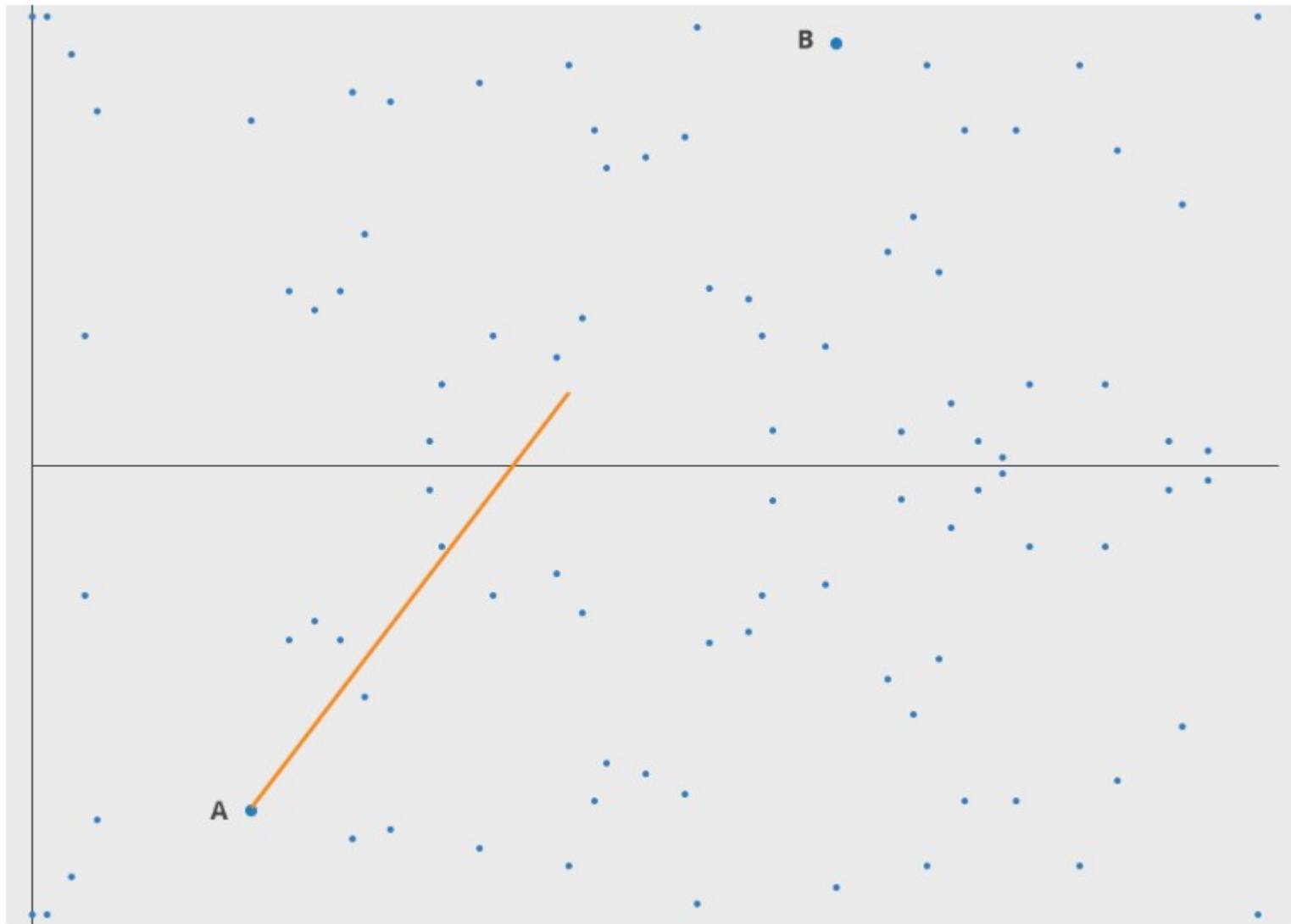

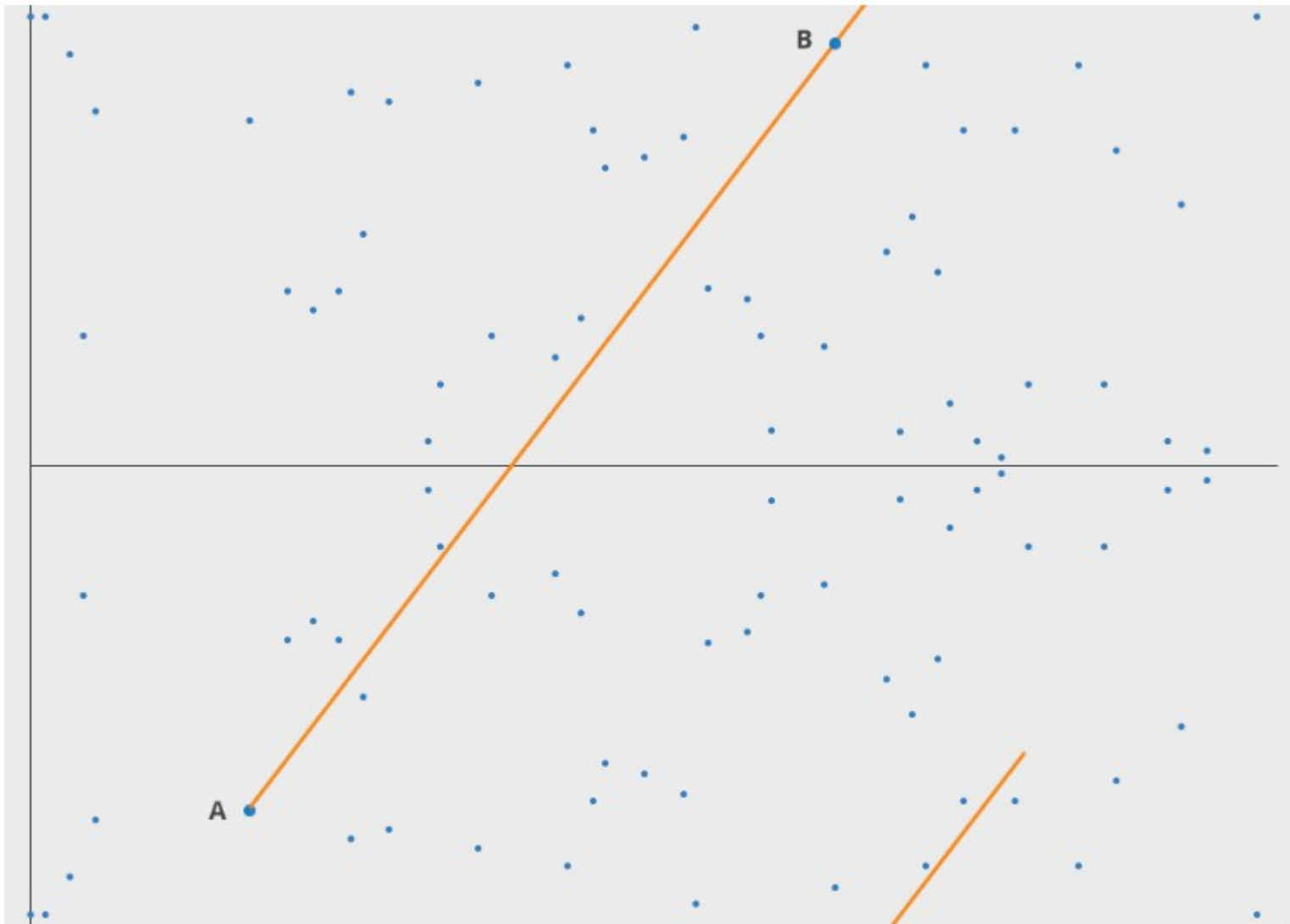

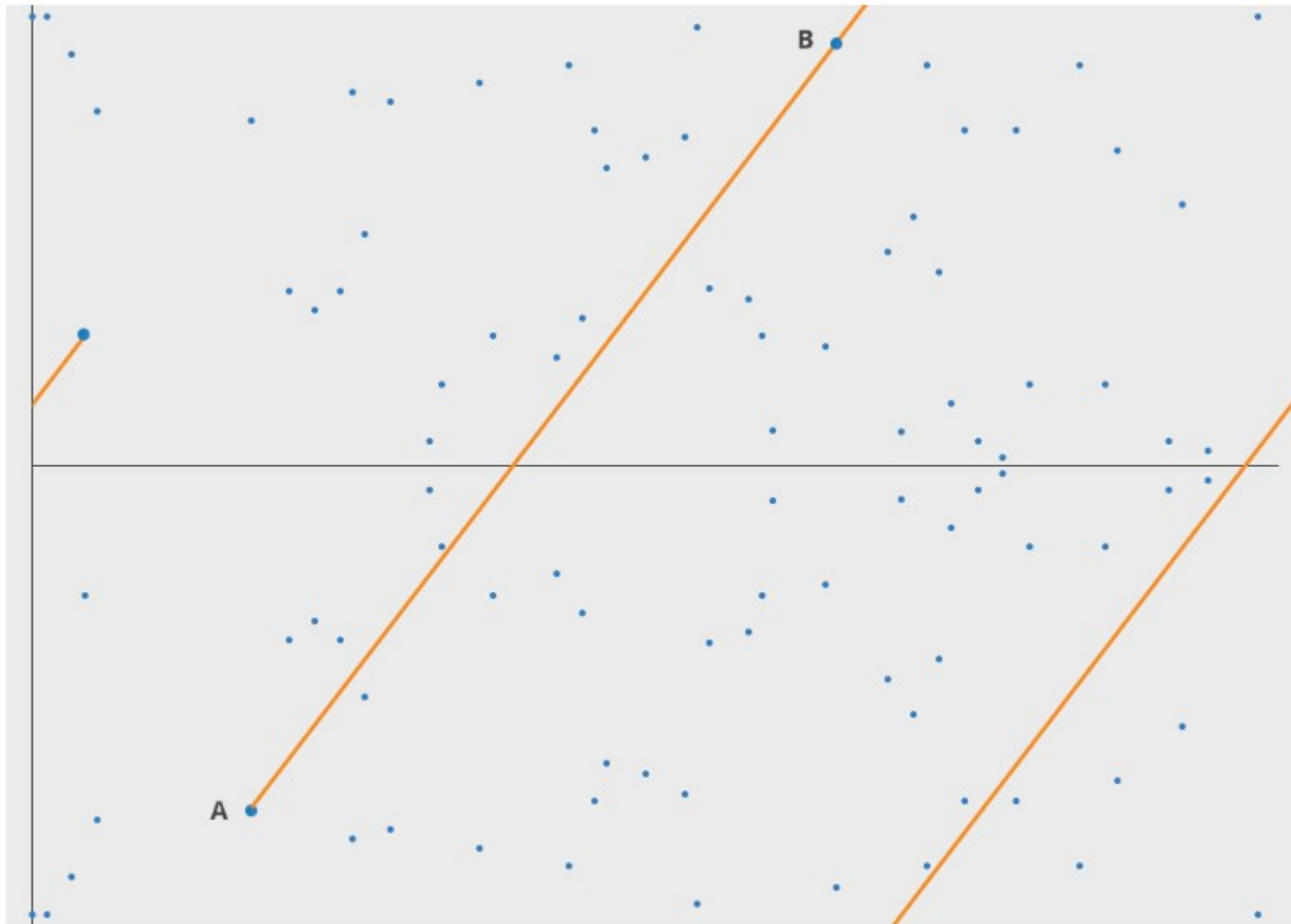

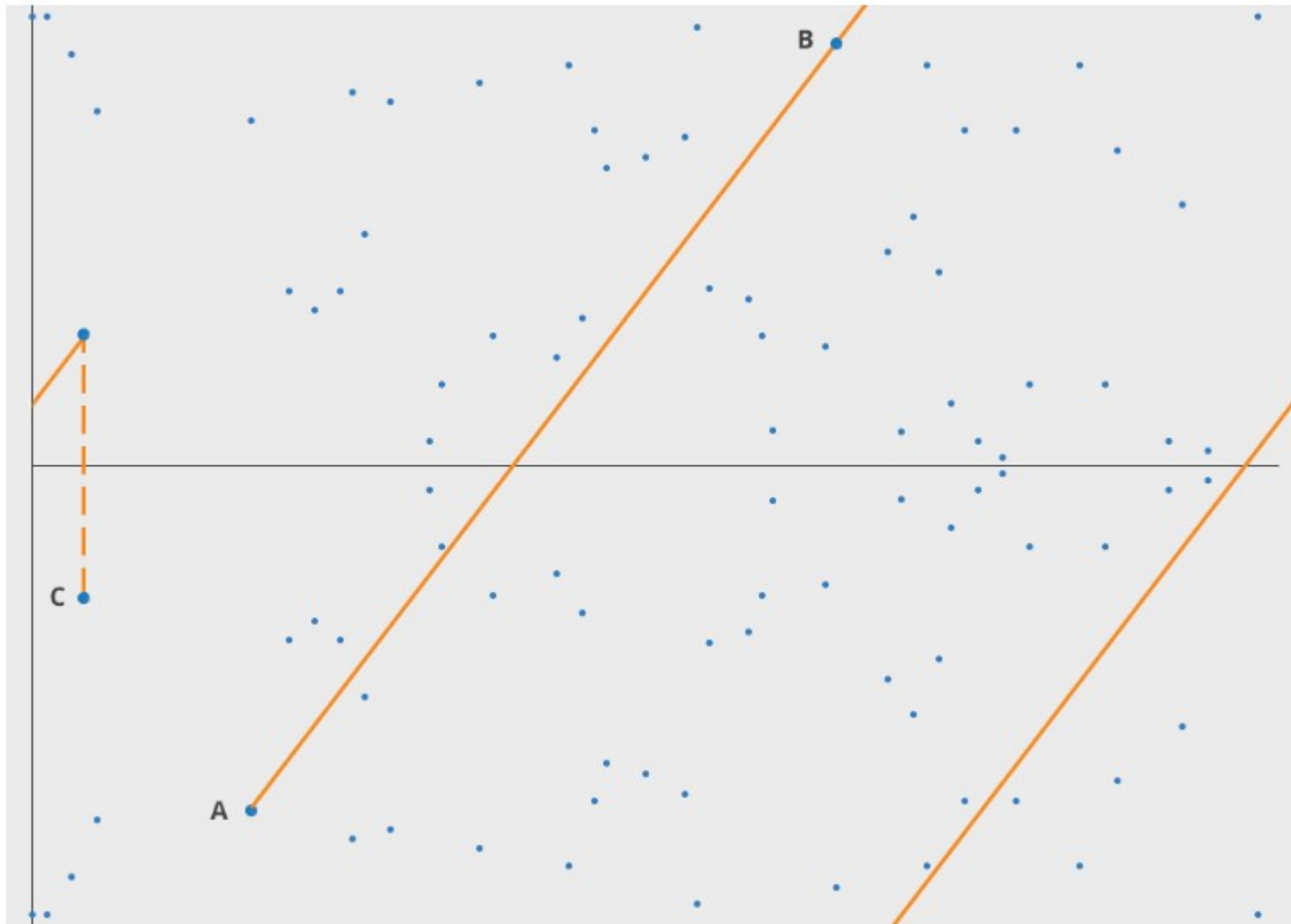

ECDH

- https://en.wikipedia.org/wiki/Elliptic-curve_Diffie%E2%80%93Hellman

Let Alice's key pair be (d_A, Q_A) and Bob's key pair be (d_B, Q_B) .

Alice computes point $(x_k, y_k) = d_A \cdot Q_B$. Bob computes point $(x_k, y_k) = d_B \cdot Q_A$.

$$d_A \cdot Q_B = d_A \cdot d_B \cdot G = d_B \cdot d_A \cdot G = d_B \cdot Q_A.$$

Can also do...

- Elliptic Curve Digital Signature Algorithm (ECDSA)
 - PlayStation 3 signing key leak
- Elliptic Curve Integrated Encryption Scheme (ECIES)



https://en.wikipedia.org/wiki/Crypto_AG#/media/File:Hagelin_CX-52-IMG_0568-white.jpg
<https://malicious.life/crypto-ag-the-greatest-espionage-operation-ever-part-1/>

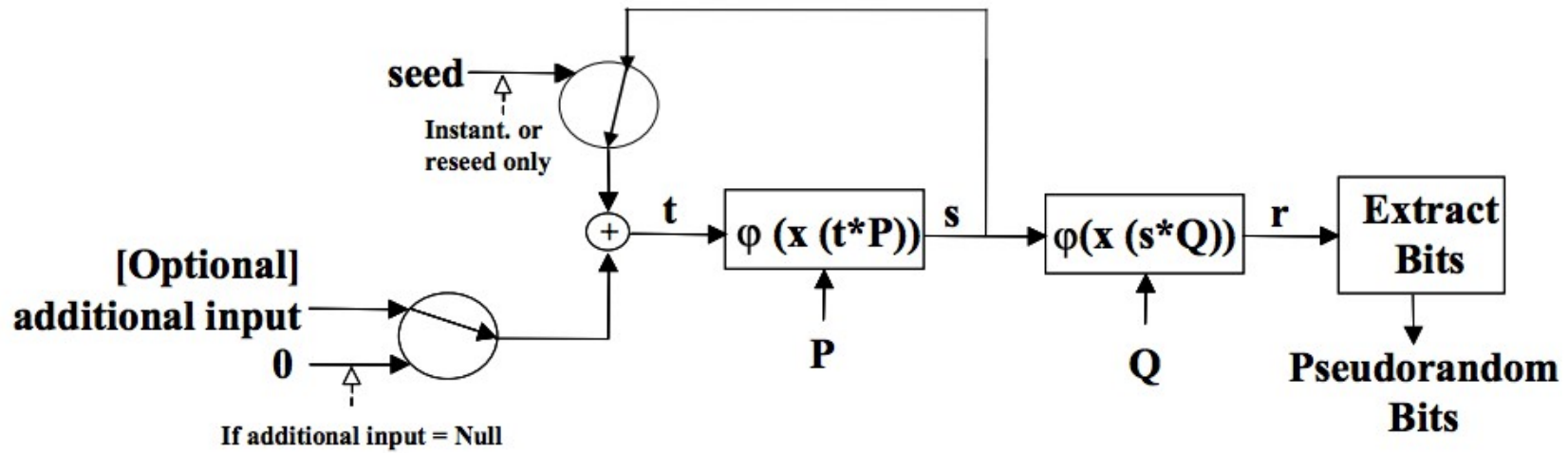

https://matthewdgreen.files.wordpress.com/2013/09/b9dec-dual_ec_diagram.png

TOP SECRET//SI//REL TO USA, FVEY

CLASSIFICATION GUIDE TITLE/NUMBER: (U//FOUO) PROJECT BULLRUN/2-16

PUBLICATION DATE: 16 June 2010

OFFICE OF ORIGIN: (U) Cryptanalysis and Exploitation Services

POC: (U) Cryptanalysis and Exploitation Services (CES) Classification Advisory Officer

PHONE: [REDACTED]

ORIGINAL CLASSIFICATION AUTHORITY: [REDACTED]

1. (TS//SI//REL) Project BULLRUN deals with NSA's abilities to defeat the encryption used in specific network communication technologies. BULLRUN involves multiple sources, all of which are extremely sensitive. They include CNE, interdiction, industry relationships, collaboration with other IC entities, and advanced mathematical techniques. Several ECIs apply to the specific sources, methods, and techniques involved. Because of the multiple sources involved in BULLRUN activities, "capabilities against a technology" does not necessarily equate to decryption.

Exploitation of Common Internet Encryption Technologies

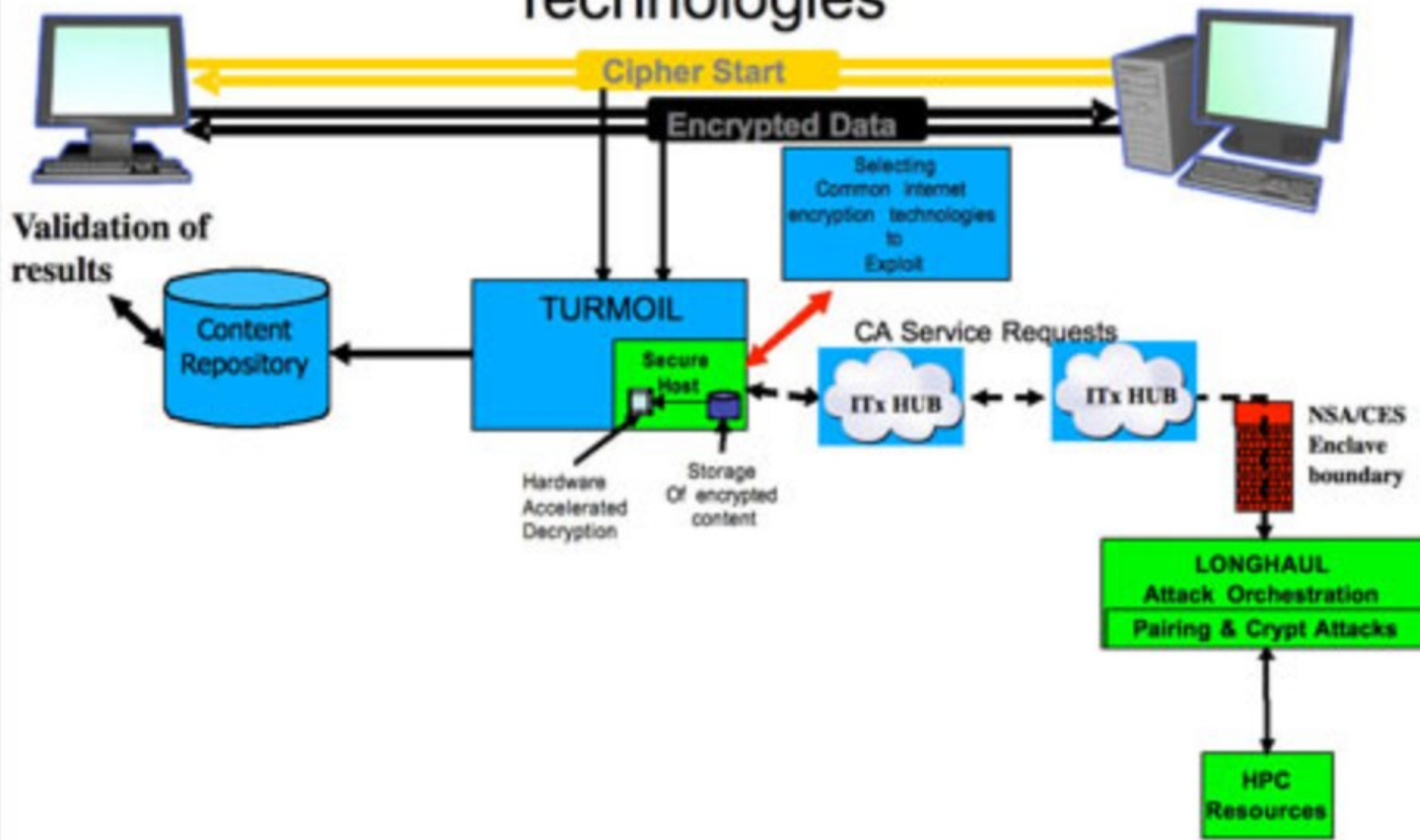

Main takeaways about ECC

- Common choice because it's more efficient, does key exchange and signatures
 - Not 100% immune to side channels or padding issues
 - Not quantum resistant

If you're interested in more...

<https://www.youtube.com/watch?v=CPHLvx6jbOc>

Back to Signal...

Silent Circle SCIMP ratchet

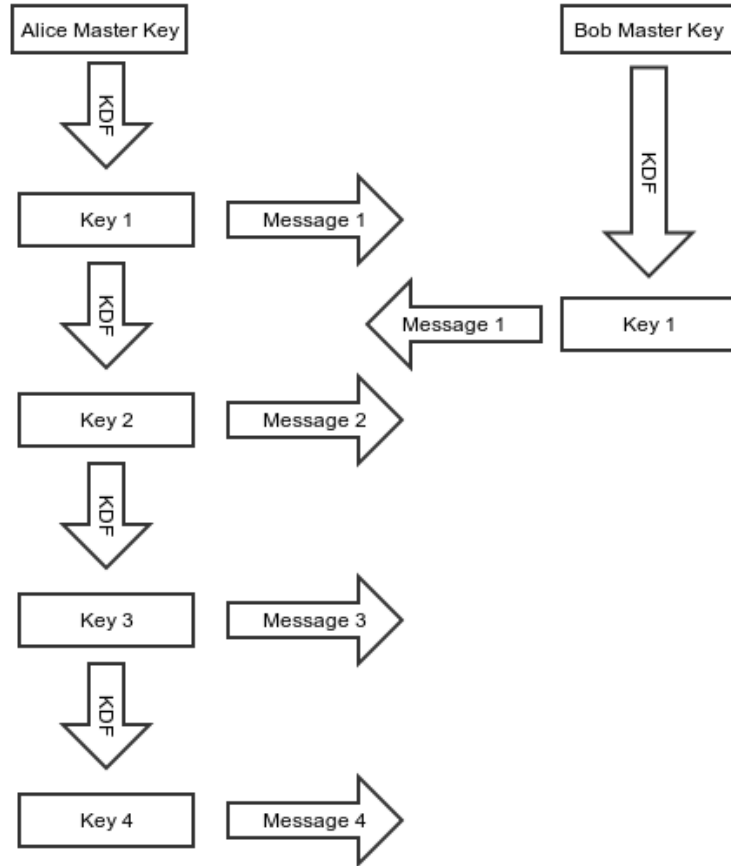

Tradeoffs

- Both have forward secrecy, but SCIMP's is better
 - In synchronous case, can ratchet and delete old key right away if Bob acknowledges it and ratchets, too
- OTR ratchet not great for multiple devices, devices that go offline
- SCIMP ratchet leaves key material around for a long time if messages are lost or out of order
- OTR ratchet “self heals”, *i.e.*, future/backward secrecy

Double Ratchet

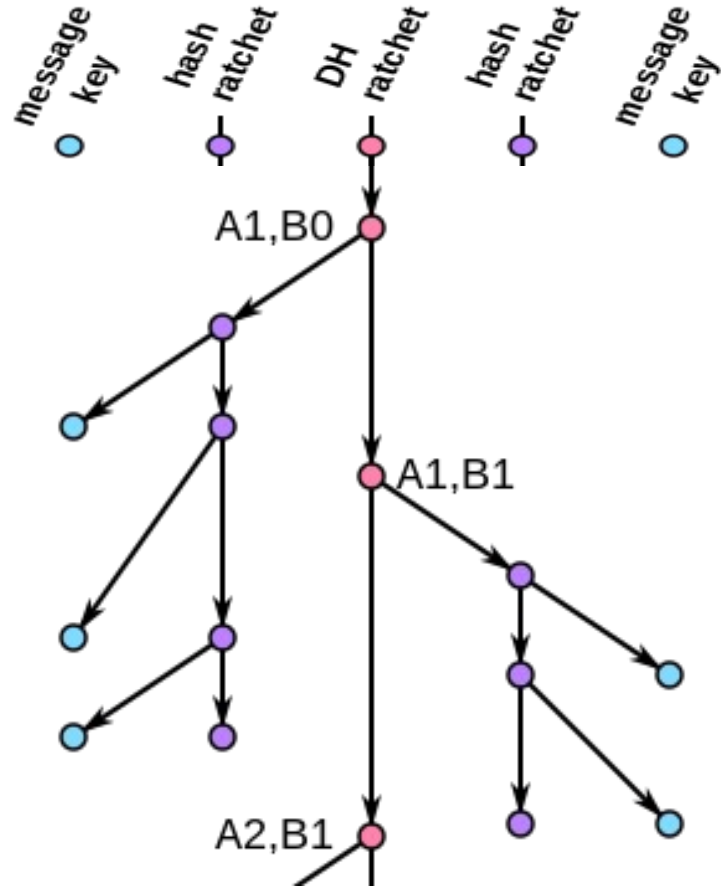

https://en.wikipedia.org/wiki/Double_Ratchet_Algorithm

X3DH

IK = Identity Key

EK = Ephemeral Key

SPK = Signed Pre-Key

OPK = One-Time Pre-Key

$SK = KDF(DH1 \parallel DH2 \parallel DH3 \parallel DH4)$

Alice's first message encrypts the two on the left, authentication for Bob's SPK comes from the signature.

Deniability?

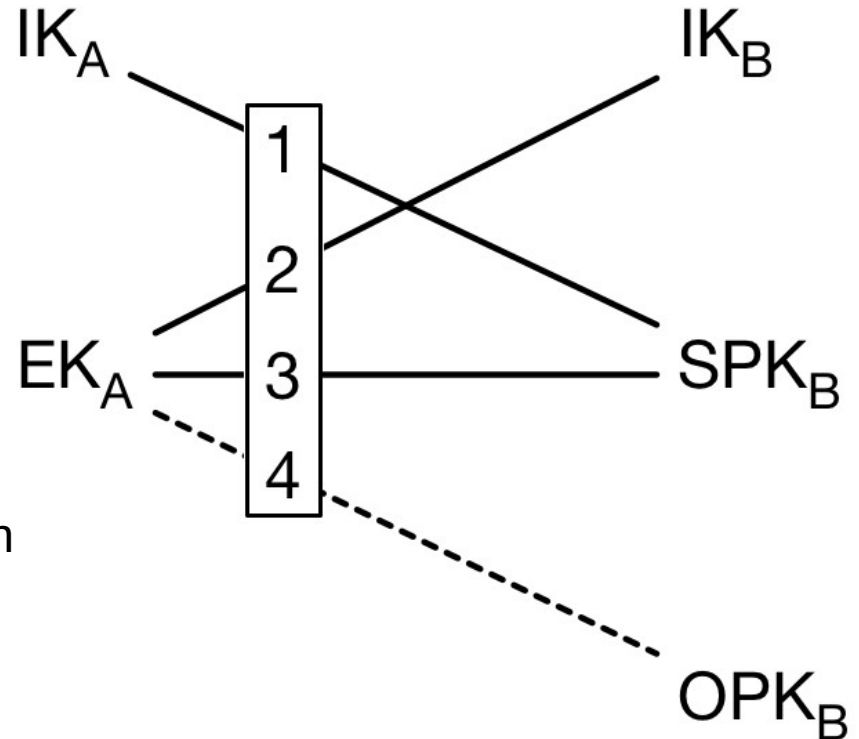

Zero Knowledge Proofs

- Used for forming groups in Signal
- “a method by which one party (the prover) can prove to another party (the verifier) that a given statement is true while the prover avoids conveying any additional information apart from the fact that the statement is indeed true”
 - https://en.wikipedia.org/wiki/Zero-knowledge_proof (also the source of the following images and examples)

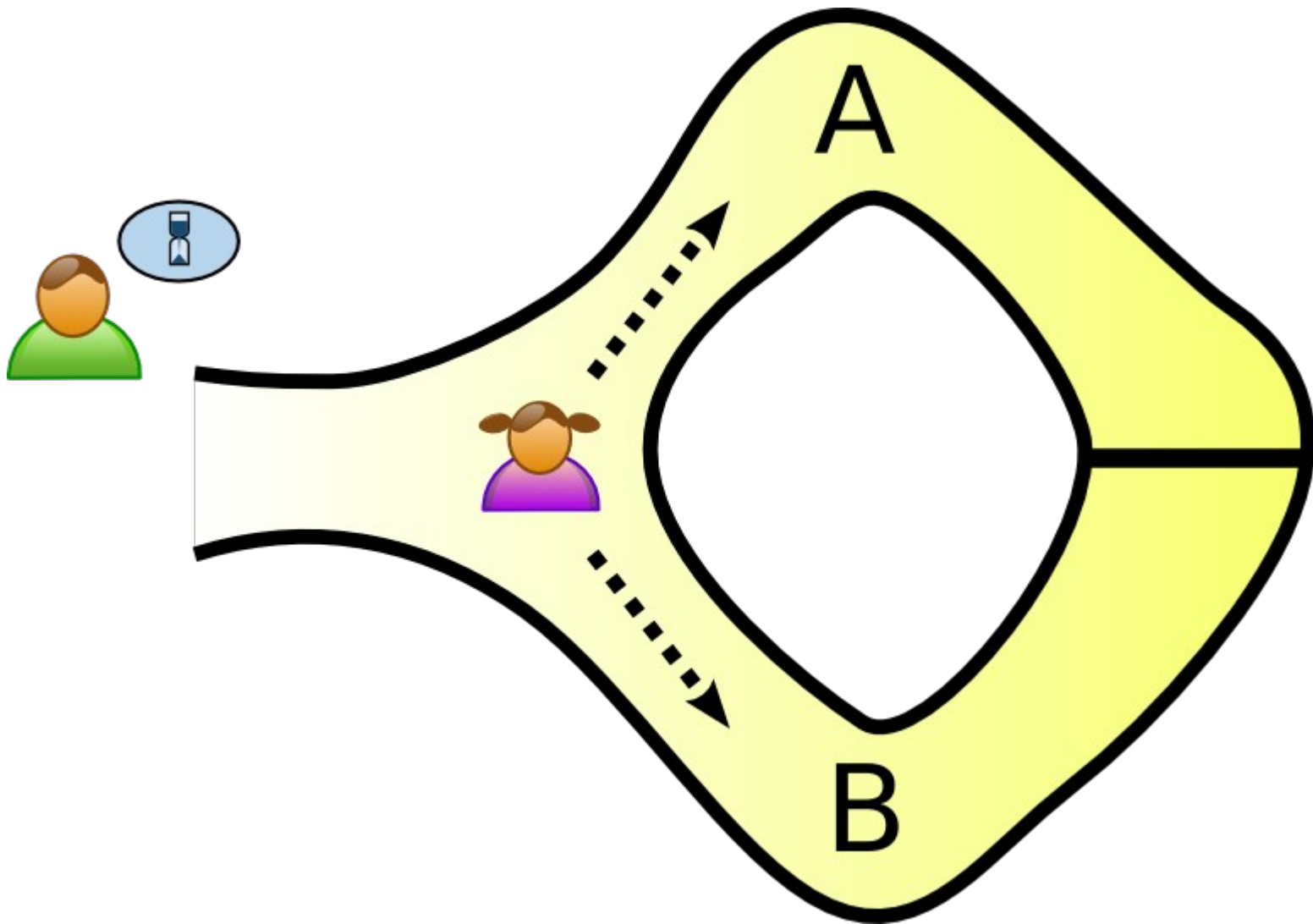
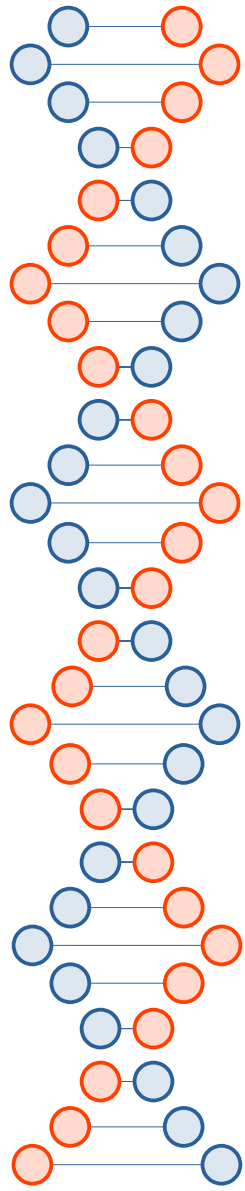

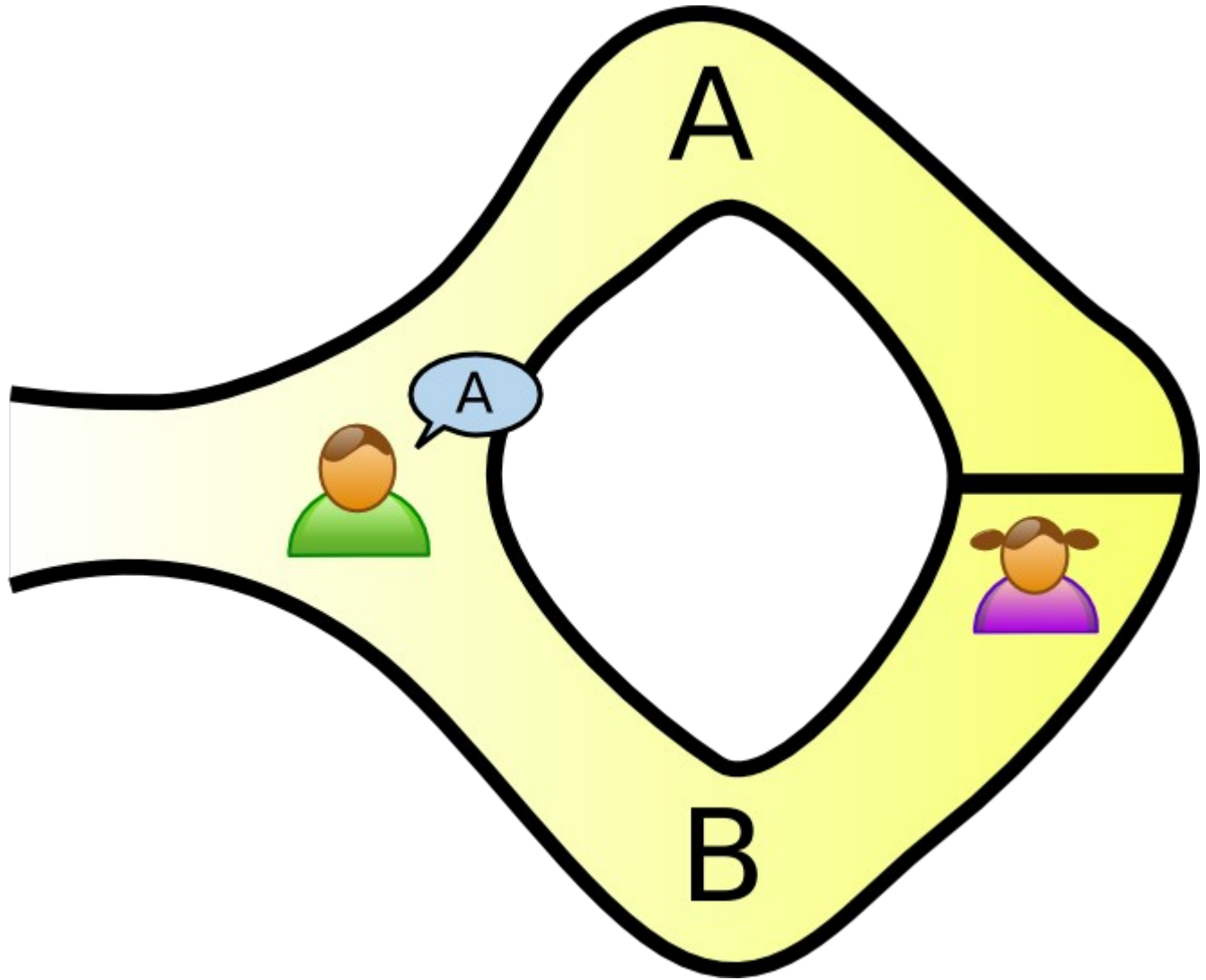
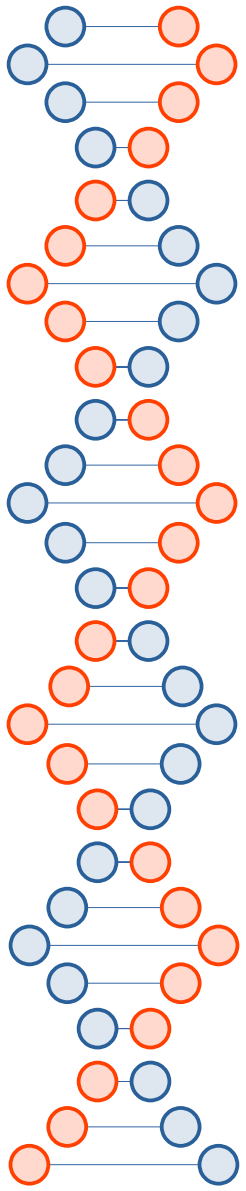

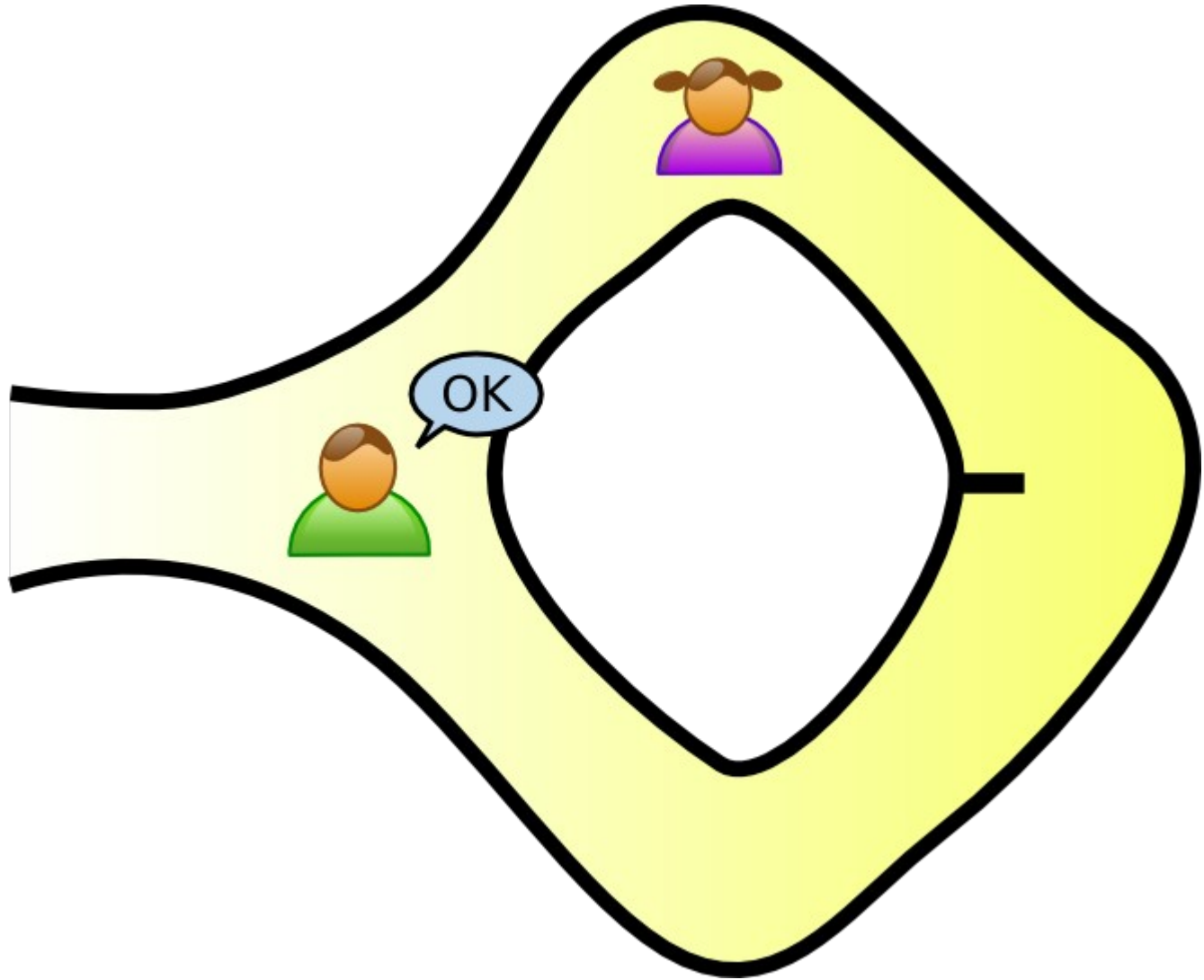
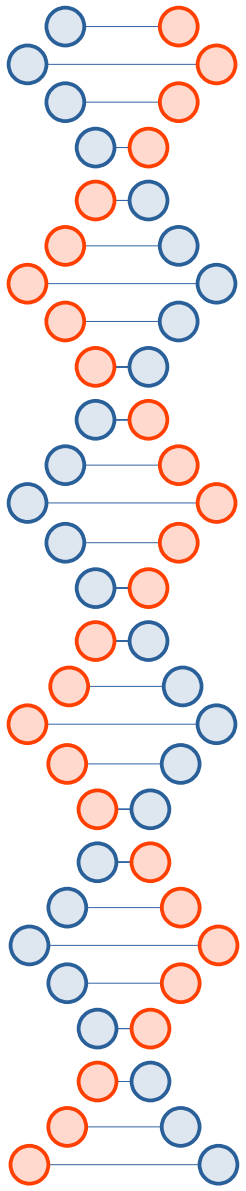

Example with discrete log

- $g^x \bmod p = y$
 - Peggy wants to prove she knows x
- Each round, Peggy computes $C = g^r \bmod p$
 - She generates r randomly
- In each round, Victor can ask for...
 - r --or--
 - **$(x + r) \bmod (p - 1)$**

$$g^{(x + r) \bmod (p - 1)} \bmod p = g^x g^r \bmod p = Cy \bmod p$$



Monitor your web services
for cyber threats with the
CrowdSec Console



[Sign Up Now](#)

Signal Messenger Introduces PQXDH Quantum-Resistant Encryption

📅 Sep 20, 2023 👤 THN

Encryption / Privacy



Foster
collaboration
between
ITops and
SecOps using
**Endpoint
Central.**



ManageEngine
Endpoint Central

FREE TRIAL





Two key differences with Signal:
-Federated
-No deniability

Messaging Layer Security (MLS)



Messaging Layer Security (MLS) is an IETF working group building a modern, efficient, secure group messaging protocol.

[View My GitHub Profile](#)

Resources

- <https://signal.org/blog/advanced-ratcheting/>
- https://en.wikipedia.org/wiki/Off-the-Record_Messaging
- https://en.wikipedia.org/wiki/Double_Ratchet_Algorithm
- <https://signal.org/docs/specifications/doubleratchet/>
- <https://signal.org/docs/specifications/x3dh/>
- <https://www.youtube.com/watch?v=7WnwSovjYMs>
- [https://en.wikipedia.org/wiki/Global_surveillance_disclosures_\(2013%E2%80%93present\)](https://en.wikipedia.org/wiki/Global_surveillance_disclosures_(2013%E2%80%93present))
- [https://en.wikipedia.org/wiki/Global_surveillance_disclosures_\(2013%E2%80%93present\)](https://en.wikipedia.org/wiki/Global_surveillance_disclosures_(2013%E2%80%93present))
- <https://thehackernews.com/2023/09/signal-messenger-introduces-pqxdh.html>

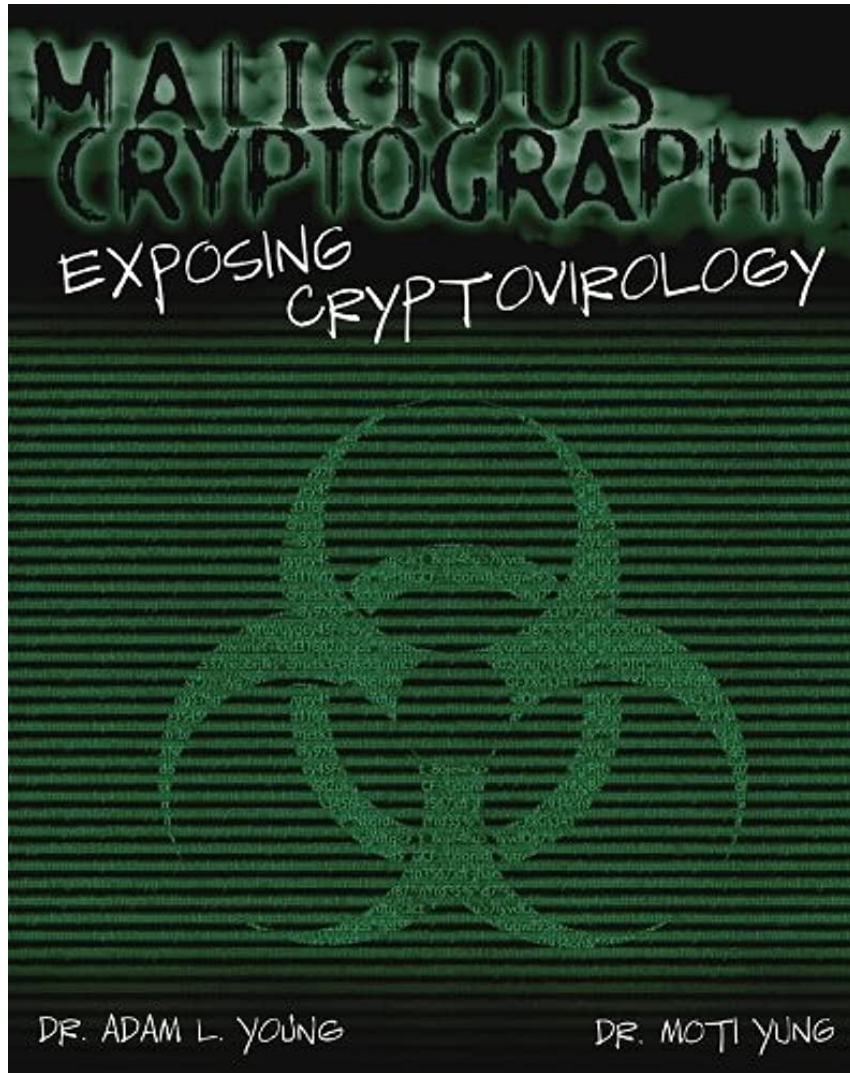
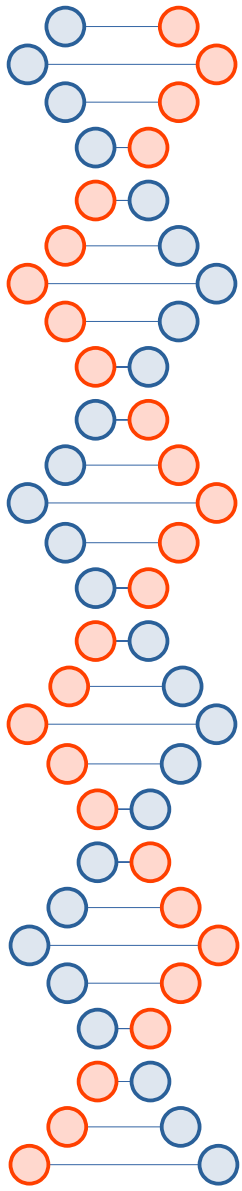

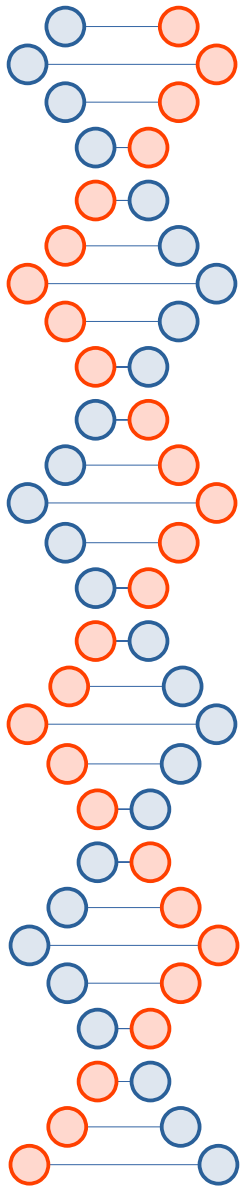

FUBSWRJUD SKBDQGGD WDVHFX ULWB
QFMDHCUFODVMOBRRO HOGSQI FWHM
TIPGKFXIR GYPREUU RKRJVTL IZKP
QFMDHCUFODVMOBR ROHOGSQ IFWHM
VKRIMHZKT IARTG WITMTLX VNKBMR
JYFWAVNYH WOFH UKKHAHZ LJBYPAF
APWNRMEPY NFW YLBBYRY QCASPGRW
GVCTXSKV ETLCE RHHEX EWIGYVMXC
NCJAEZRCL ASJL YOOL ELDPNFCTEJ
KZGXBWOZIX PGI VLLI BIAMKCZQBG
BOXOSNFQZOG XZM CCZS ZRDBTQHSX
CRYPTOGRAPHY AND DATA SECURITY
DSZQUPHSBQIZ BOE EBUBT FQVJSJUZ
GVCTXSKVETLC ERH HEXEWI GYVMXC
VKRIMHZKT IAR TGW WTMTLXV NKBMR
JYFWAVNYHWOF HUKK HAHZLJB YPAF
TIPGKFXIRGYPR EUUR KRJVTLI ZKP
QFMDHCUFODVMOBRRO HOGSQIF WHM
DSZQUPHSBQIZBOEEBUBTFDV SJUZ
NCJAEZRCLA SJLYOOL ELDPN FCTEJ
KZGXBWOZIXPGIVLLI BIAM KCZQBG
PELCGBT ENCULNAQQN GNF RPHEVGL
IXEVZU MXGVNEGTTJGG ZG YKIAOXE
FUBSW RJUDSKBDQGG DW DVHFXULWB
GVCT XSKVETLCERH HEX EWIGYVMXC
PEL CGBTENCULNA QQNG NFRPHEVGL
PEL CGBTENCULN AQNG NFRPHEVGL
KZG XBWOZIXPG IVLLI BIAMKCZQBG
PEL CGBTENCULNAQQNG NFRPHEVGL
IXE VZUMXGVN EGTJGGZ GYKIAOXE

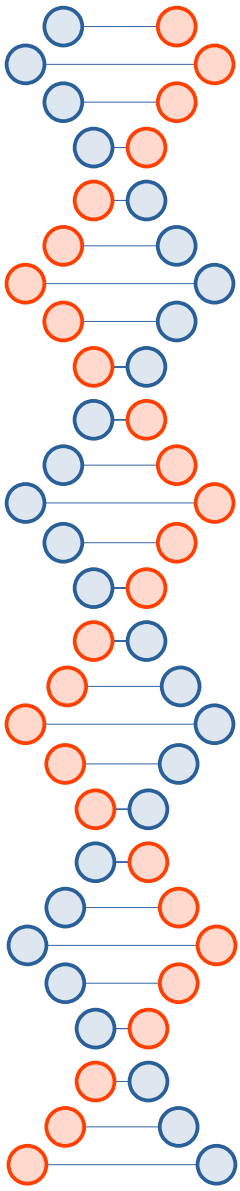

Cryptography Engineering by Ferguson *et al.*

