

Hash functions and certificates

CSE 548 Fall 2024

jedimaestro@asu.edu

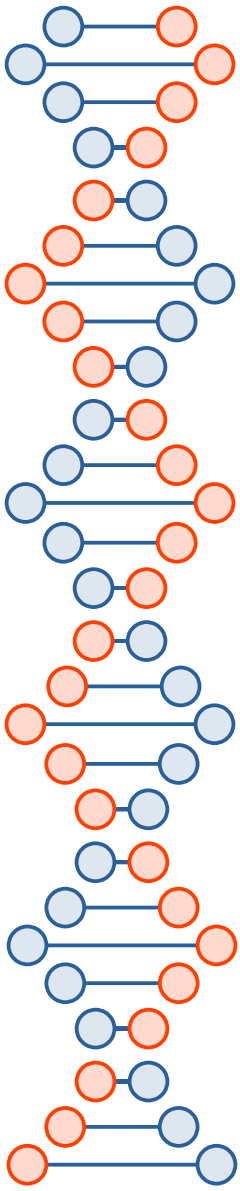



Interesting...

https://media.ccc.de/v/25c3-3023-en-making_the_theoretical_possible

Also check out:

<https://www.win.tue.nl/hashclash/rogue-ca/>

BREAKPOINTINGBAD

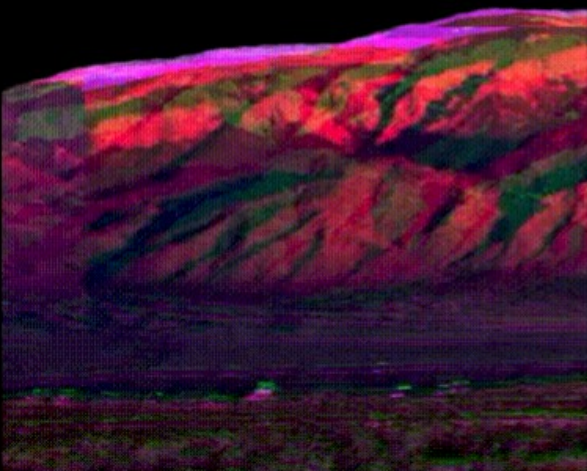

We are a non-profit founded in 20...
combined experience focusing on...
goal is to provide technical expertise and capabilities to at risk populations subjected f

Certificate Viewer: breakpointingbad.com

General Details

Issued To

Common Name (CN)	breakpointingbad.com
Organization (O)	<Not Part Of Certificate>
Organizational Unit (OU)	<Not Part Of Certificate>

Issued By

Common Name (CN)	R3
Organization (O)	Let's Encrypt
Organizational Unit (OU)	<Not Part Of Certificate>

Validity Period

Issued On	Thursday, December 22, 2022 at 10:57:13 PM
Expires On	Wednesday, March 22, 2023 at 10:57:12 PM

Fingerprints

SHA-256 Fingerprint	81 05 41 B0 19 8B 06 9C 90 20 7F B3 EE 60 2E AB BD 64 25 F9 D8 DE 87 7D FD 70 34 AC F9 F5 DE 92
SHA-1 Fingerprint	C1 95 59 2C 66 12 BC 36 71 7E 99 C9 60 98 12 0A B8 02 1D 47

**General** Details**Issued To**

Common Name (CN)	breakpointingbad.com
Organization (O)	<Not Part Of Certificate>
Organizational Unit (OU)	<Not Part Of Certificate>

Issued By

Common Name (CN)	R3
Organization (O)	Let's Encrypt
Organizational Unit (OU)	<Not Part Of Certificate>

Validity Period

Issued On	Thursday, December 22, 2022 at 10:57:13 PM
Expires On	Wednesday, March 22, 2023 at 10:57:12 PM

Fingerprints

SHA-256 Fingerprint	81 05 41 B0 19 8B 06 9C 90 20 7F B3 EE 60 2E AB BD 64 25 F9 D8 DE 87 7D FD 70 34 AC F9 F5 DE 92
SHA-1 Fingerprint	C1 95 59 2C 66 12 BC 36 71 7E 99 C9 60 98 12 0A B8 02 1D 47

breakpointingbad.com

Certificate Fields

▼ breakpointingbad.com

▼ Certificate

Version

Serial Number

Certificate Signature Algorithm

Issuer

▼ Validity

Not Before

Field Value

04:B5:2A:1D:FD:B3:AC:F1:34:37:27:94:9F:F5:A8:5A:12:E6

Export...

breakpointingbad.com

Certificate Fields

▼ breakpointingbad.com

▼ Certificate

Version

Serial Number

Certificate Signature Algorithm

Issuer

▼ Validity

Not Before

Field Value

PKCS #1 SHA-256 With RSA Encryption

Certificate Fields

▼ breakpointingbad.com

▼ Certificate

Version

Serial Number

Certificate Signature Algorithm

Issuer

▼ Validity

Not Before

Field Value

CN = R3

O = Let's Encrypt

C = US

breakpointingbad.com

Certificate Fields

Certificate Signature Algorithm

Issuer

▼ Validity

Not Before

Not After

Subject

▼ Subject Public Key Info

Subject Public Key Algorithm

Field Value

3/22/23, 10:57:12 PM MST

Export...

breakpointingbad.com

Certificate Fields

Certificate Signature Algorithm

Issuer

▼ Validity

Not Before

Not After

Subject

▼ Subject Public Key Info

Subject Public Key Algorithm

Field Value

CN = breakpointingbad.com

breakpointingbad.com

Certificate Fields

Not After

Subject

▼ Subject Public Key Info

Subject Public Key Algorithm

Subject's Public Key

▼ Extensions

Certificate Key Usage

Extended Key Usage

Field Value

Modulus (2048 bits):

DC DA F0 96 47 5C 62 91 27 27 AD B2 95 EE 3D 51
CF 26 EB EC 27 EE ED 2E 9F DA 1D BF 83 2F 12 F0
EA CC 96 5B 8C C1 3E A1 C6 46 90 4D E5 93 20 E1
5C 9B 62 BB 82 3A 7F 77 7C 85 CB 8C F3 0F B9 0D
38 24 9C 0D 39 8C FF F4 B5 AD 0A 94 75 AA F9 41

Export

Certificate Fields

▼ breakpointingbad.com

▼ Certificate

Version

Serial Number

Certificate Signature Algorithm

Issuer

▼ Validity

Not Before

Field Value

98 2F 52 F3 68 5E 6D BC 18 2C 93 42 8B C5 41 D1
40 B4 0F 53 D9 BD BA 22 F9 52 90 76 37 F0 C4 56
31 F8 8D C7 B8 21 3E FB 0F 83 B8 A7 CF F3 B4 A1

Public Exponent (17 bits):
01 00 01

Export...

Certificate Hierarchy

▼ Builtin Object Token:ISRG Root X1

▼ R3

breakpointingbad.com

Certificate Fields

Subject's Public Key

▼ Extensions

Certificate Key Usage

Extended Key Usage

Certificate Basic Constraints

Certificate Subject Key ID

Certification Authority Key ID

Authority Information Access

Field Value

Critical
Is not a Certification Authority

▼ R3

breakpointingbad.com

Certificate Fields

Certificate Subject Alternative Name

Certificate Policies

OID.1.3.6.1.4.1.11129.2.4.2

Certificate Signature Algorithm

Certificate Signature Value

▼ Fingerprints

SHA-256 Fingerprint

SHA-1 Fingerprint

Field Value

81 05 41 B0 19 8B 06 9C 90 20 7F B3 EE 60 2E AB
BD 64 25 F9 D8 DE 87 7D FD 70 34 AC F9 F5 DE 92

Export



General

Details

Certificate Hierarchy

▼ Builtin Object Token:ISRG Root X1

▼ R3

breakpointingbad.com

Certificate Fields

▼ R3

▼ Certificate

Version

Serial Number

Certificate Signature Algorithm

Issuer

▼ Validity

Not Before

Field Value

CN = ISRG Root X1
O = Internet Security Research Group
C = US

Export...

▼ R3

breakpointingbad.com

Certificate Fields

▼ R3

▼ Certificate

Version

Serial Number

Certificate Signature Algorithm

Issuer

▼ Validity

Not Before

Field Value

CN = ISRG Root X1

O = Internet Security Research Group

C = US

Export...

▼ Builtin Object Token:ISRG Root X1

▼ R3

breakpointingbad.com

Certificate Fields

Subject's Public Key

▼ Extensions

Certificate Key Usage

Extended Key Usage

Certificate Basic Constraints

Certificate Subject Key ID

Certification Authority Key ID

Authority Information Access

CRL Distribution Points

Field Value

Critical

Is a Certification Authority

Maximum number of intermediate CAs: 0

Certificate Hierarchy

▼ Builtin Object Token:ISRG Root X1

▼ R3

breakpointingbad.com

Certificate Fields

▼ Builtin Object Token:ISRG Root X1

▼ Certificate

Version

Serial Number

Certificate Signature Algorithm

Issuer

▼ Validity

Not Before

Field Value

CN = ISRG Root X1
O = Internet Security Research Group
C = US

- ▼ Builtin Object Token:ISRG Root X1
 - ▼ R3
 - breakpointingbad.com

Certificate Fields

- Subject's Public Key
- ▼ Extensions
 - Certificate Key Usage
 - Certificate Basic Constraints
 - Certificate Subject Key ID
 - Certificate Signature Algorithm
 - Certificate Signature Value
- ▼ Fingerprints

Field Value

Critical
Is a Certification Authority
Maximum number of intermediate CAs: unlimited

 Privacy and security

 Appearance

 Search engine

 Default browser

 On startup

 Languages

 Downloads

 Accessibility

 System

 Reset settings

 Extensions 

 About Chromium

org-GlobalSign nv-sa

org-GoDaddy.com, Inc.

org-Google Trust Services LLC

org-Government Root Certification Authority

org-GUANG DONG CERTIFICATE AUTHORITY CO.,LTD.

org-Hellenic Academic and Research Institutions Cert. Authority

org-Hongkong Post

org-IdenTrust

org-Internet Security Research Group

org-IZENPE S.A.

org-Japan Certification Services, Inc.

org-Krajowa Izba Rozliczeniowa S.A.

org-LuxTrust S.A.

Why hash functions?

- Speed
- Error detection (e.g., checksum)
- Security and privacy

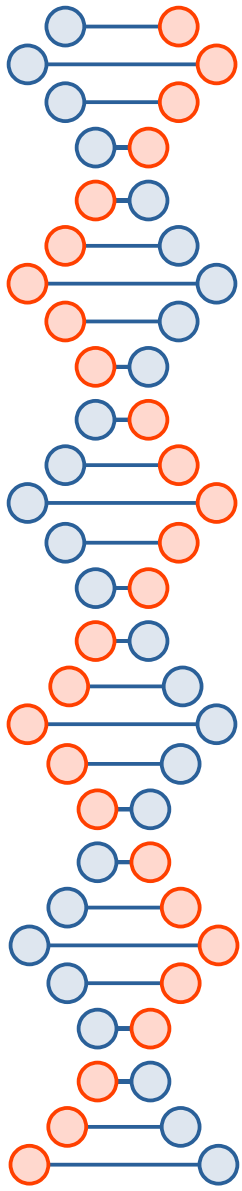



Why cryptographic hash functions?

- Unique identifier for an object
- Integrity of an object
 - *E.g.*, message authentication codes
- Digital signatures
 - Sign the digest
 - *E.g.*, 1024-bit RSA, 100MB message, 256-bit digest
- Passwords
- Proof of work

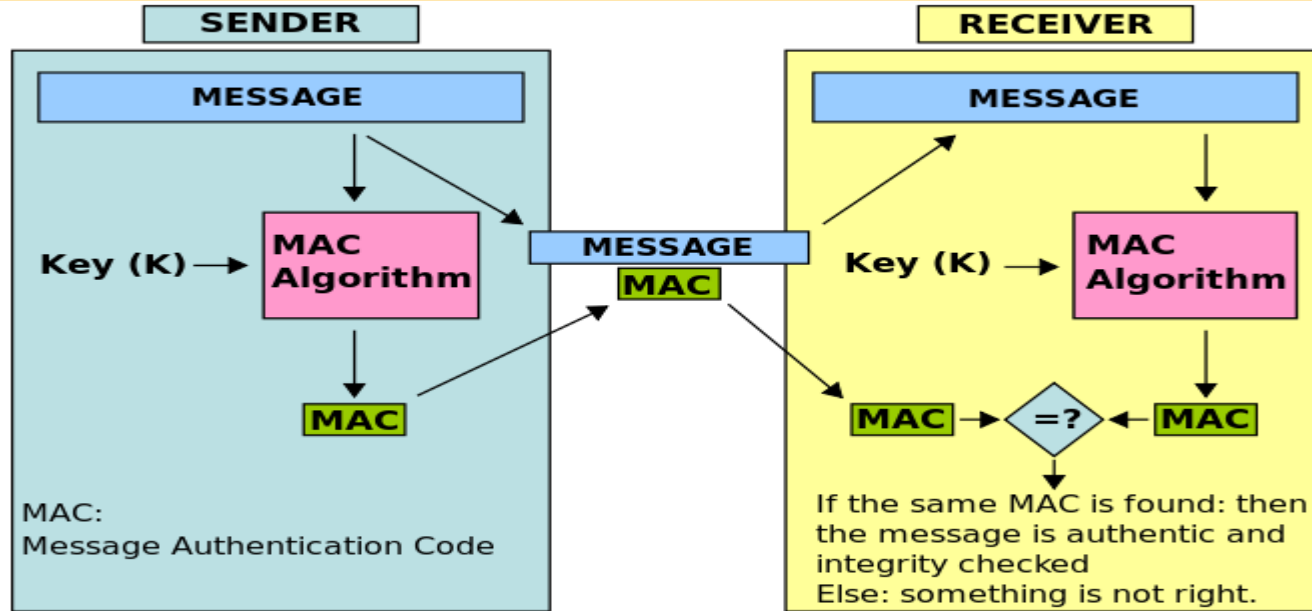

<https://en.wikipedia.org/wiki/HMAC>

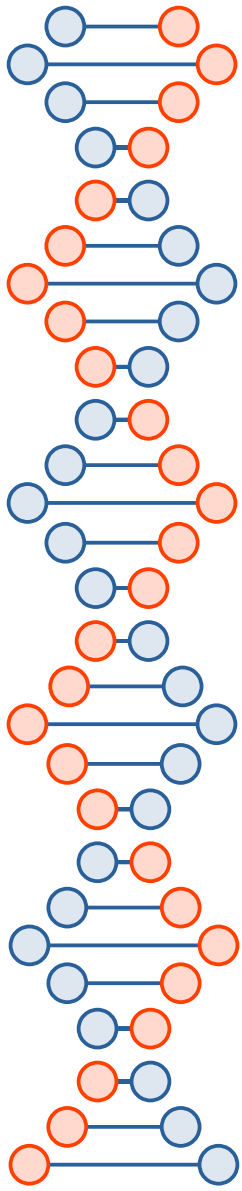
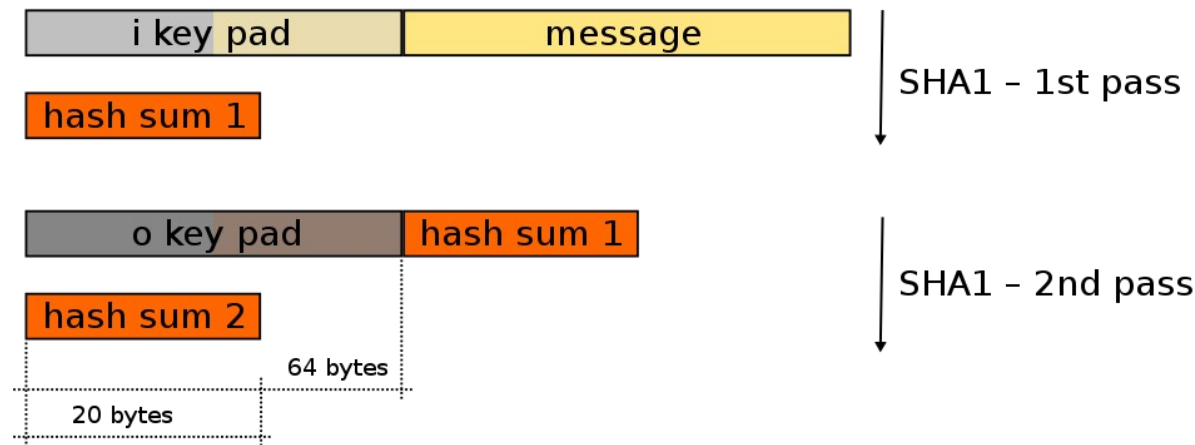
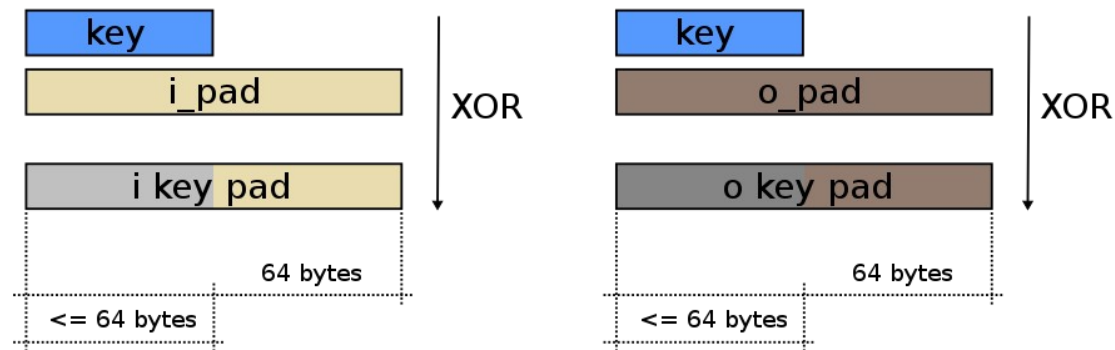

Hash function example

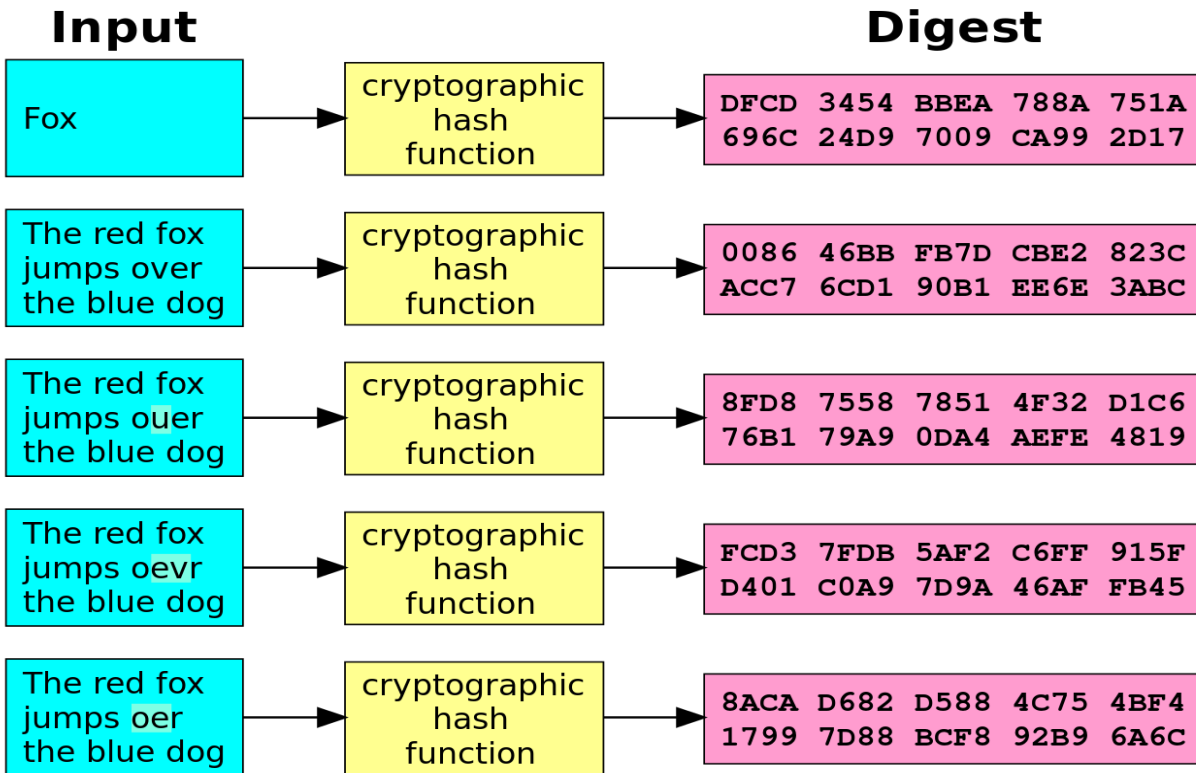

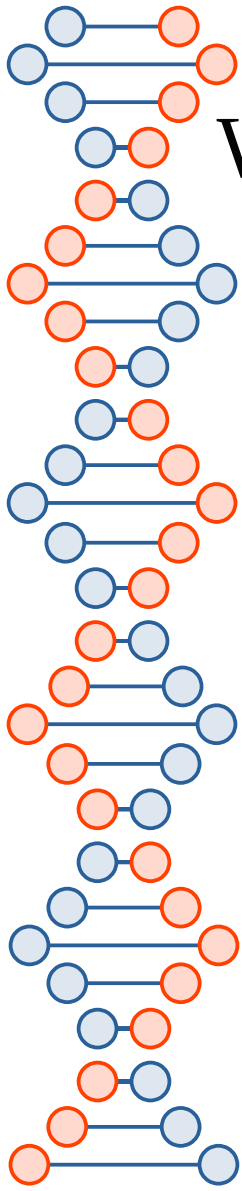

What makes a hash function cryptographic?

- One-way function
- Deterministic (same input, same output)
- Infeasible to find message that digests to specific hash value
- Infeasible to find two messages that digest to the same hash
- Avalanche effect (small change in message leads to big changes in digest---digests seemingly uncorrelated)
- *Still want it to be quick*

Example algorithms

- MD5: 128-bit digest, seriously broken
- SHA-1: 160-bit digest, not secure against well-funded adversaries
- SHA-3: 224 to 512 bit digest, adopted in August of 2015
- CRC32: not cryptographic, very poor choice

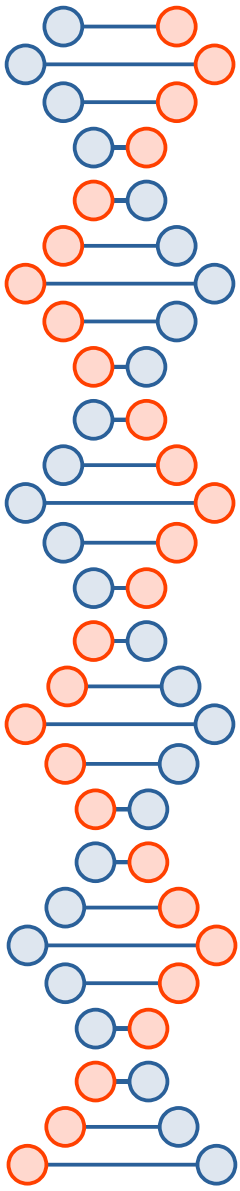

Example algorithms

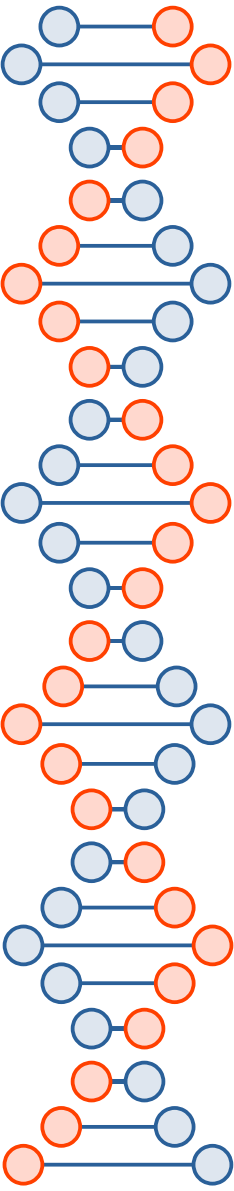
- 
- MD5: 128-bit digest, seriously broken
 - SHA-1: 160-bit digest, not secure against well-funded adversaries
 - SHA-3: 224 to 512 bit digest, adopted in August of 2015
 - CRC32: not cryptographic, very poor choice



Property #1

- Pre-image resistance
- Given h , it should be infeasible to find m such that $h = \text{hash}(m)$

Neither MD5 nor SHA-3 are broken in this way, but MD5 digests are small.



Property #2

- Second pre-image resistance
- Given a message m_1 , it should be infeasible to find another message m_2 such that...
 $hash(m_1) = hash(m_2)$

Neither MD5 nor SHA-3 are broken in this way, but MD5 digests are small.



Property #3

- Collision resistance
- It should be infeasible to find two messages, m_1 and m_2 such that...
 $hash(m_1) = hash(m_2)$

SHA-3 is not broken in this way, MD5 broken in seconds on your laptop, SHA-1 with \$100K or so.



Wang Xiaoyun



- Tsinghua University
- Contributed a lot of ideas to cracking MD5, SHA-0, and SHA-1

Length extension attack

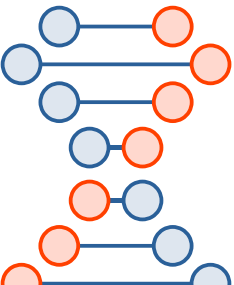

```
jedi@mariposa:~$ echo "password='lDEnr45#d3'&donut=choc&quantity=1" | md5sum
91a9fc74a98997dba291a26a91c9648e -
jedi@mariposa:~$ echo "password='lDEnr45#d3'&donut=choc&quantity=100" | md5sum
8fdd2d4515bcba887b1b80a653f21e0c -
```

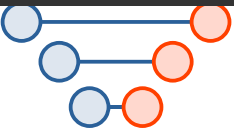

```
jedi@mariposa:~$ echo "password=[REDACTED]'&donut=choc&quantity=1" | md5sum
91a9fc74a98997dba291a26a91c9648e -
jedi@mariposa:~$ echo "password=[REDACTED]'&donut=choc&quantity=100" | md5sum
8fdd2d4515bcba887b1b80a653f21e0c -
```

MD5 and SHA-1 vulnerable, SHA-3 is not



Length extension attack

- One issue is if the attacker doesn't know the password
- Another issue is if the password is different but the attacker finds a collision later on
- **MD5 and SHA-1 are vulnerable, SHA-3 is not**

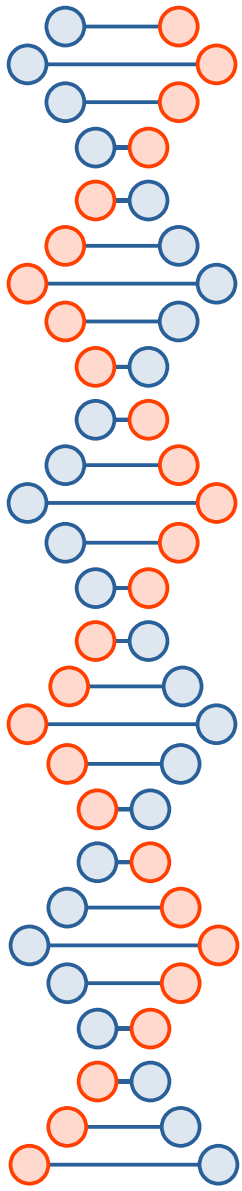



MD5

- Pad to multiple of 512 bits
- 4 rounds
- 4 32-bit words at a time
- Concatenate them at the end for a 128-bit digest
- F is non-linear, varies by round

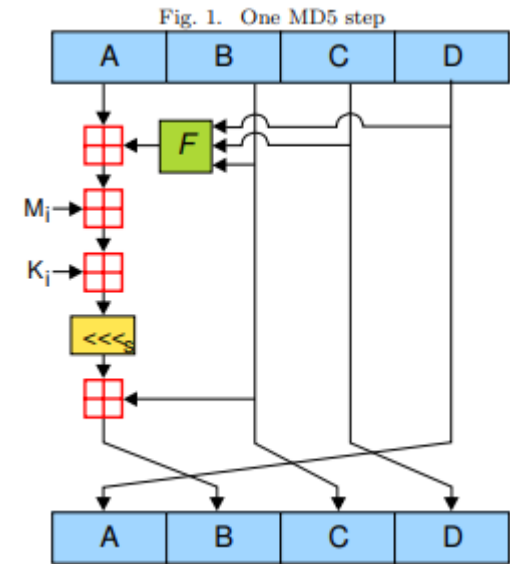

Round (i)	$F(X, Y, Z)$	g
0	$(X \wedge Y) \vee (\neg X \wedge Z)$	i
1	$(X \wedge Z) \vee (Y \wedge \neg Z)$	$(5 \times i + 1) \bmod 16$
2	$(X \oplus Y \oplus Z)$	$i(3 \times i + 5) \bmod 16$
3	$(Y \oplus (X \vee \neg Z))$	$(7 \times i) \bmod 16$



SHA-3

- Sponge construction, 1600 bits of internal state

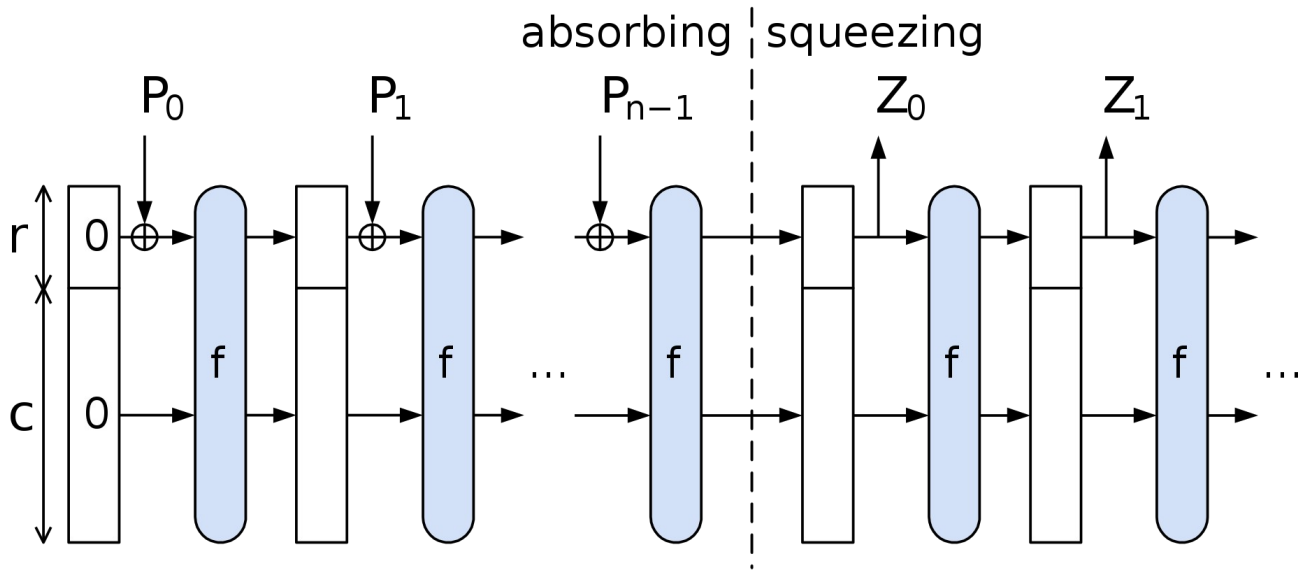

<https://en.wikipedia.org/wiki/SHA-3>

Birthday attack

- Probability of collision is 1 in 2^n , but the expected number of hashes until two of them collide is $\sqrt{2^n}=2^{n/2}$
 - Why? Third try has two opportunities to collide, fourth has three opportunities, fifth has six, and so on...

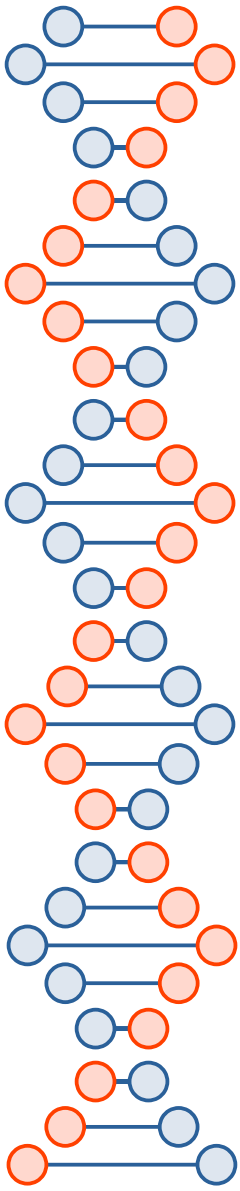

24 people, same birthday?

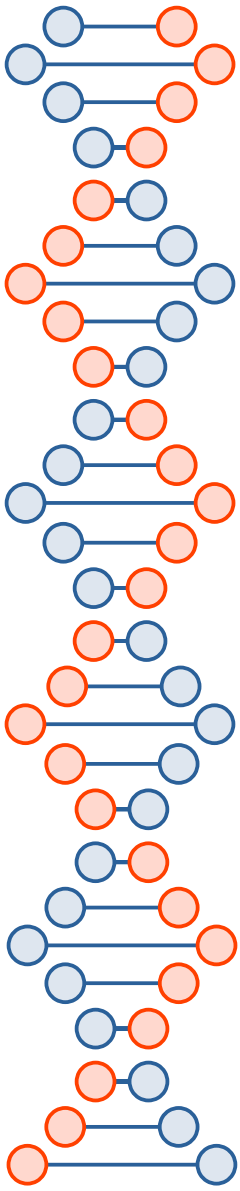

(1)

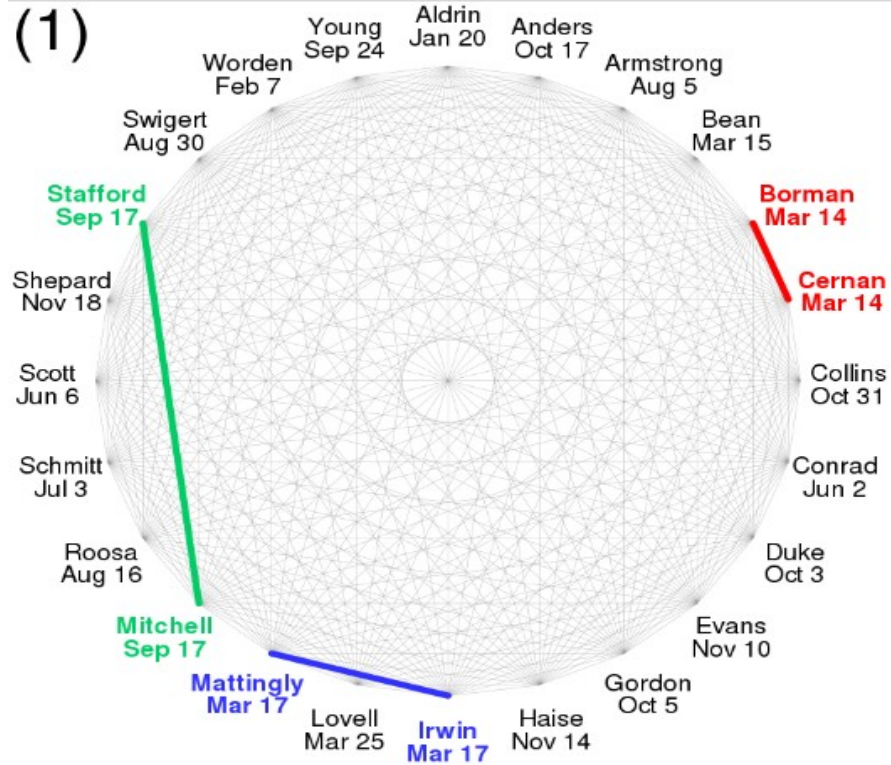

Chosen-prefix collision attack

- Given two prefixes p_1 and p_2 , find m_1 and m_2 such that $hash(p_1 || m_1) = hash(p_2 || m_2)$
- p_1 and p_2 could be domain names in a certificate, images, PDFs, *etc.* ... any digital image.

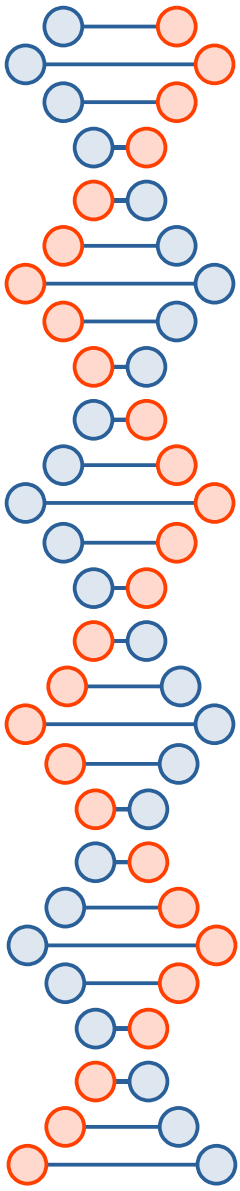



Ingredients for a practical chosen prefix attack on MD5

- Collision attack on MD5
 - That works for any initialization vector (so you can put bits in front)
- Length extension attack
 - So you can put identical bits on the end
- Birthday attack
 - So you can bridge the prefix to a block that meets the requirements of the collision attack

MD5 collision attack by Wang and Yu

$$C_0 = (0, 0, 0, 0, 2^{31}, 0, 0, 0, 0, 0, 0, 0, 2^{15}, 0, 0, 2^{31}, 0)$$

and

$$C_1 = (0, 0, 0, 0, 2^{31}, 0, 0, 0, 0, 0, 0, 0, -2^{15}, 0, 0, 2^{31}, 0)$$

Fig. 1. One MD5 step

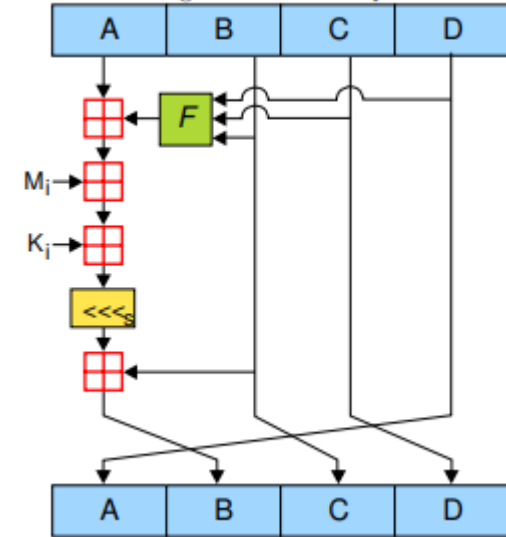

Round (i)	$F(X, Y, Z)$	g
0	$(X \wedge Y) \vee (\neg X \wedge Z)$	i
1	$(X \wedge Z) \vee (Y \wedge \neg Z)$	$(5 \times i + 1) \bmod 16$
2	$(X \oplus Y \oplus Z)$	$i(3 \times i + 5) \bmod 16$
3	$(Y \oplus (X \vee \neg Z))$	$(7 \times i) \bmod 16$



An example

Both have digest 79054025255fb1a26e4bc422aef54eb4

```
d131dd02c5e6eec4693d9a0698aff95c2fcab58712467eab4004583eb8fb7f89  
55ad340609f4b30283e488832571415a085125e8f7cdc99fd91dbdf280373c5b  
d8823e3156348f5bae6dacd436c919c6dd53e2b487da03fd02396306d248cda0  
e99f33420f577ee8ce54b67080a80d1ec69821bcb6a8839396f9652b6ff72a70
```

```
d131dd02c5e6eec4693d9a0698aff95c2fcab50712467eab4004583eb8fb7f89  
55ad340609f4b30283e4888325f1415a085125e8f7cdc99fd91dbdf7280373c5b  
d8823e3156348f5bae6dacd436c919c6dd53e23487da03fd02396306d248cda0  
e99f33420f577ee8ce54b67080280d1ec69821bcb6a8839396f965ab6ff72a70
```

<https://www.mscs.dal.ca/~selinger/md5collision/>



Short Chosen-Prefix Collisions for MD5 and the Creation of a Rogue CA Certificate

Marc Stevens¹, Alexander Sotirov²,
Jacob Appelbaum³, Arjen Lenstra^{4,5}, David Molnar⁶,
Dag Arne Osvik⁴, and Benne de Weger⁷

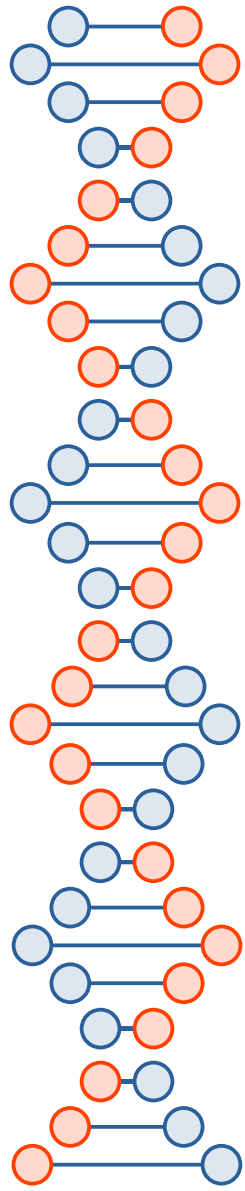

legitimate website certificate		rogue CA certificate
serial number		serial number
commercial CA name		commercial CA name
validity period		validity period
domain name	chosen prefixes	rogue CA name
		1024 bit RSA public key
2048 bit RSA public key	collision bits	v3 extensions
v3 extensions "CA = FALSE"	identical suffixes	"CA = TRUE"
		tumor

Fig. 1. The to-be-signed parts of the colliding certificates



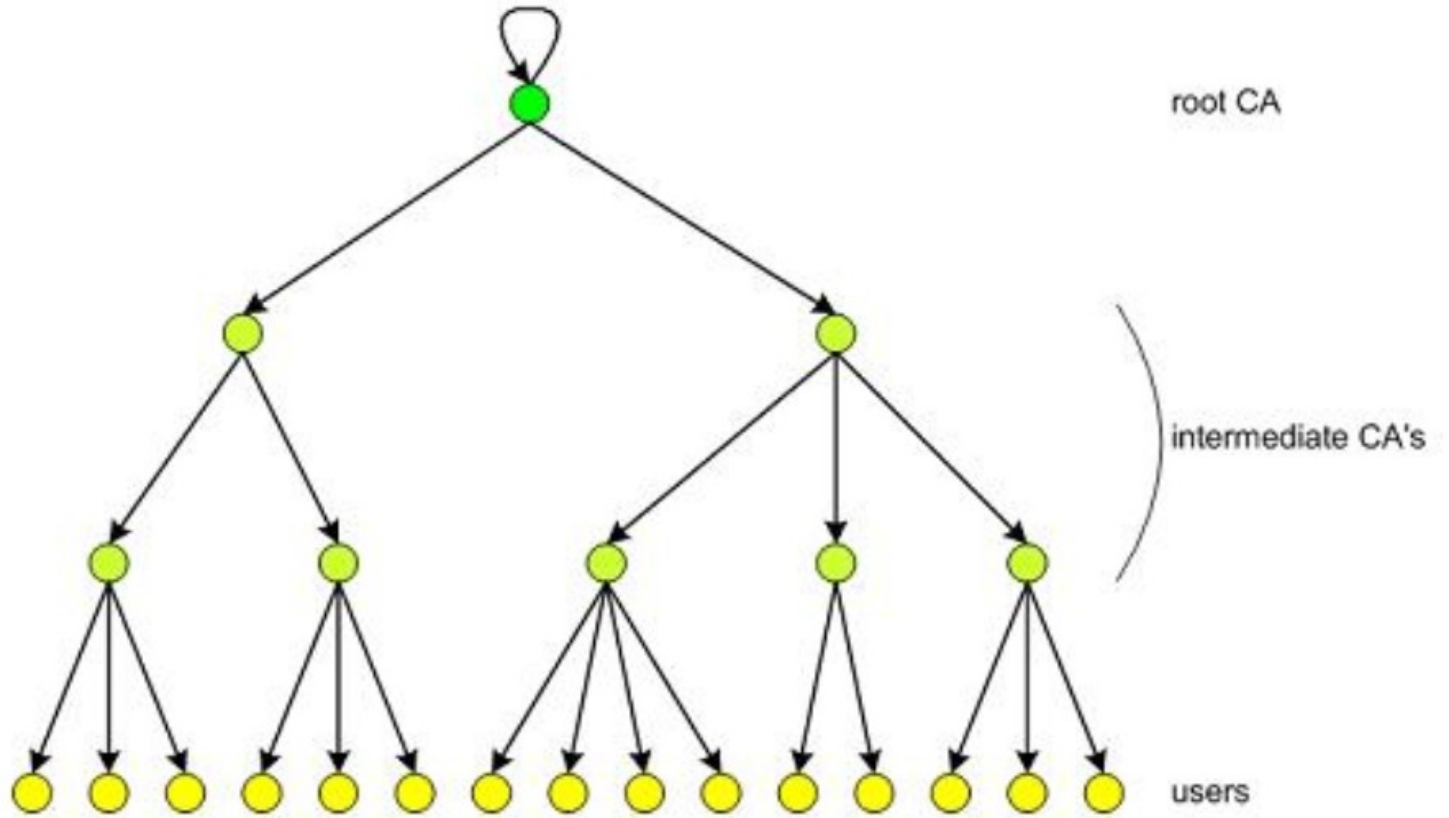
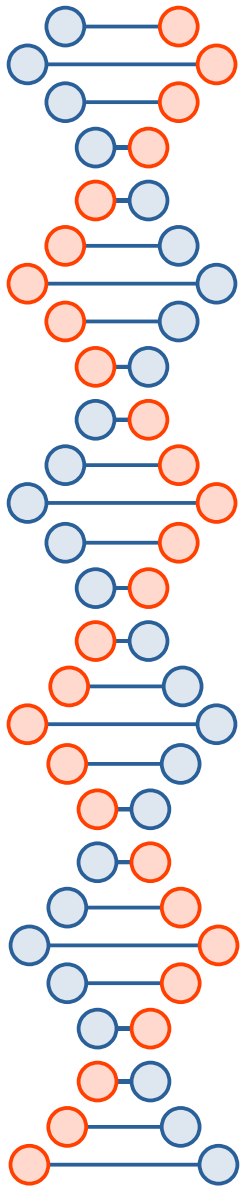

Slide from MD5 Considered Harmful Today, Creating a rogue CA certificate by Sotirov *et al.*



CN=Starfield Services Root Certificate Authority
- G2,O=Starfield Technologies,
Inc.,L=Scottsdale,ST=Arizona,C=US



CN=COMODO RSA Certification
Authority,O=COMODO CA
Limited,L=Salford,ST=Greater
Manchester,C=GB

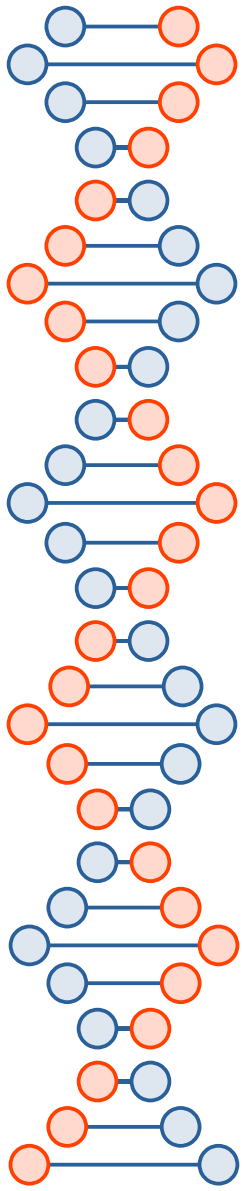

CN=Amazon Root CA 3,O=Amazon,C=US



CN=Microsoft RSA Root Certificate Authority
2017,O=Microsoft Corporation,C=US



CN=Autoridad de Certificacion Firmaprofesional
CIF A62634068,C=ES

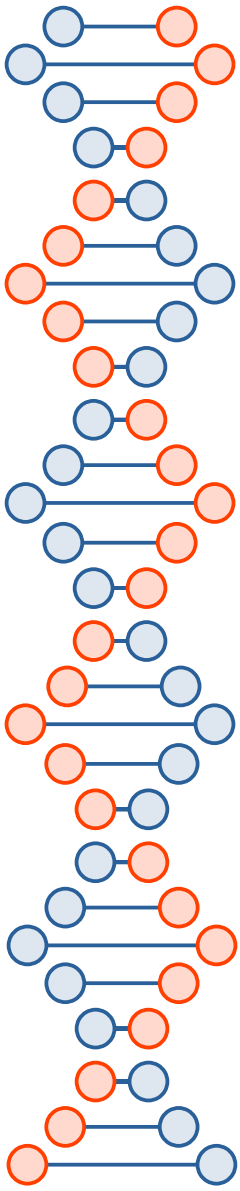

OU=certSIGN ROOT CA G2,O=CERTSIGN
SA,C=RO

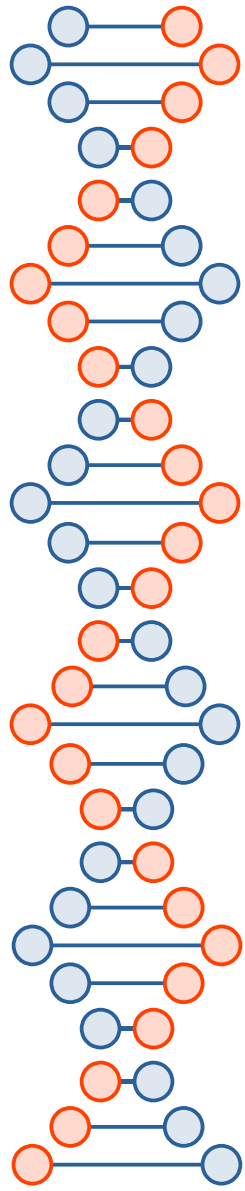

CN=TUBITAK Kamu SM SSL Kok Sertifikasi -
Surum 1,OU=Kamu Sertifikasyon Merkezi -
Kamu SM,O=Turkiye Bilimsel ve Teknolojik
Arastirma Kurumu - TUBITAK,L=Gebze -
Kocaeli,C=TR

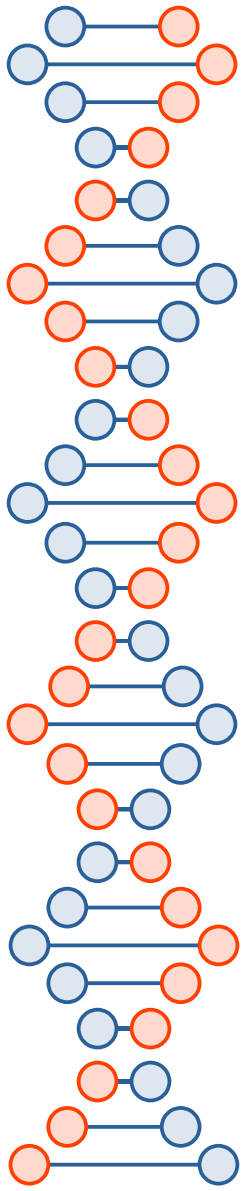

CN=CFCA EV ROOT,O=China Financial
Certification Authority,C=CN

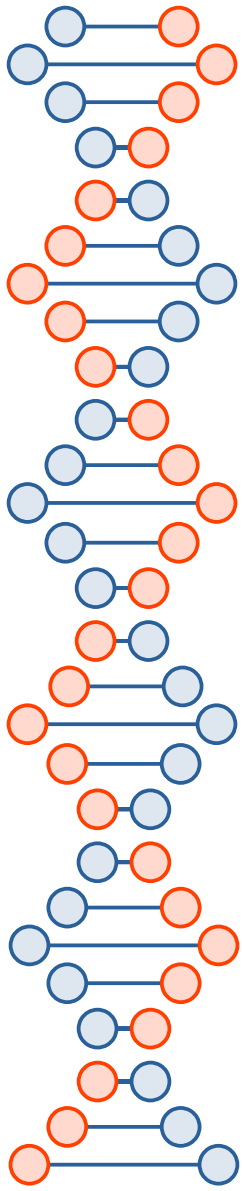

CN=GlobalSign,OU=GlobalSign ECC Root CA -
R5,O=GlobalSign

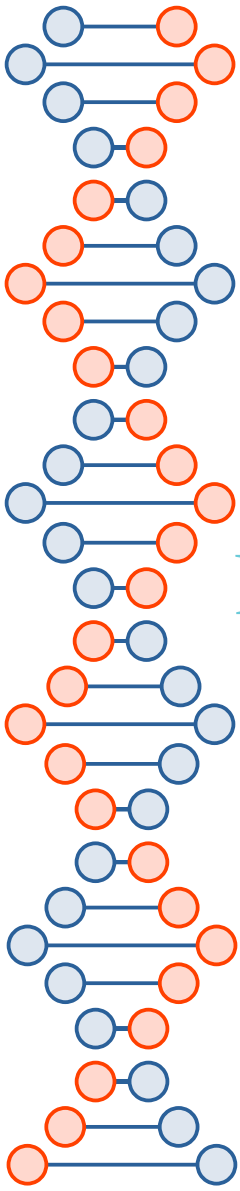

Also interesting...

<https://www.youtube.com/watch?v=fZ1R9RliM1w>

References

- [Cryptography Engineering] *Cryptography Engineering: Design Principles and Applications*, by Niels Ferguson, Bruce Schneier, and Tadayoshi Kohno. Wiley Publishing, 2010.
- Lots of images and info plagiarized from Wikipedia

